

**1801M58**  
Burner, Front

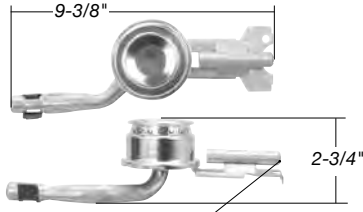

Flash tube slightly recessed from mounting bracket

burner head porting



**1801M59**  
Burner, Rear

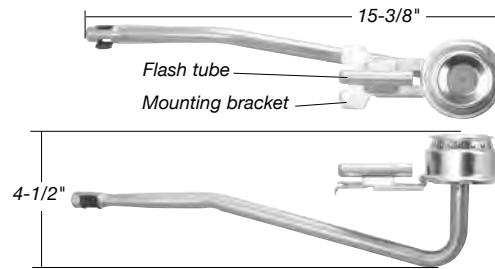

**1802F36**  
Burner, Oven

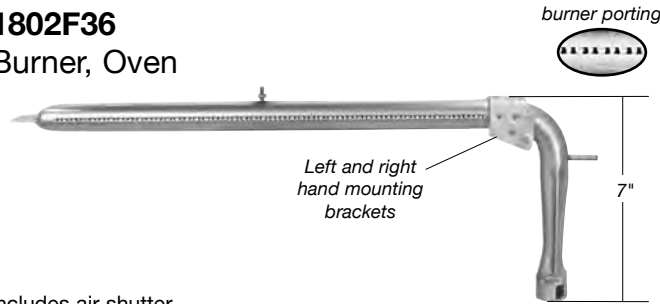

Includes air shutter

**1801M71**  
Burner, Sealed/Cap  
3-1/4" dia base



**5900**  
Grate  
1" height  
6-5/8" dia



**1805L296**  
Harness, Top Burner  
Spark Switch



Used on 2006  
20", 24", 30" & 36"  
spark ignition models

**1801B149**  
Harness, Top Pilot  
Double Tube

19-5/8" overall  
Used on 36" models



**1801B154**  
Shield, Pilot

**1802A300**  
Igniter, Oven Glow  
17" lead wires  
Flat type

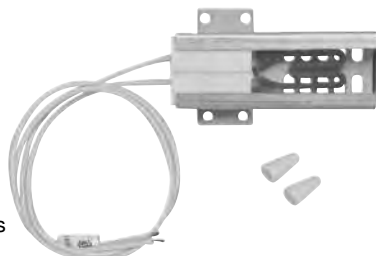

Includes (2) porcelain wire nuts  
Has stripped wire ends  
Used on type-7 models with glow ignition  
Used with thermostat #1802A302 and safety valve #1802A301

**1802A344**  
Igniter, Oven Glow  
18-1/4" lead wires  
Round type

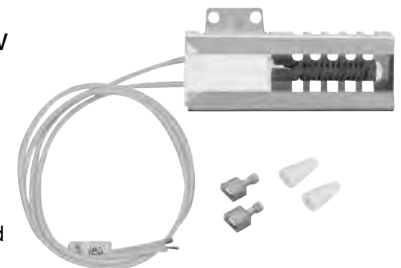

Includes (2) porcelain wire nuts and (2) .250" insulated male terminals  
Has stripped wire ends

CURRENT PRICING CAN BE FOUND ON OUR WEBSITE

All logos, trademarks, part numbers, photos & illustrations are intended solely for identification. Items offered for sale are not represented to be manufactured by the company that built the original equipment.

PHONE: 800-843-0903 • FAX: 800-344-1848 • WEB: [www.pdqsupplyinc.com](http://www.pdqsupplyinc.com) • FB: [facebook.com/pdqsupplyinc](https://facebook.com/pdqsupplyinc)

GAS RANGE PARTS

### 1801B169

37" lead wire

### 1801B170

70" lead wire

### 1801B175

51" lead wire

Igniter, Oven Spark

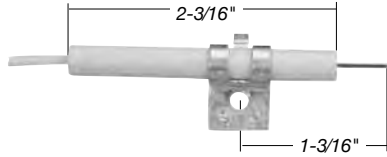

Has a .110" female terminal end

### 1801B112

Igniter, Top  
Burner Spark

60" lead wire



### 5292

Strap, Spark

Must order separately



### 1801B163

66" lead wire

### 1801B164

66" lead wire

### 1801B166

66" lead wire

Igniter, Top Burner Spark

### 1801B140

Strap, Spark

Must order separately



.110" female terminal end

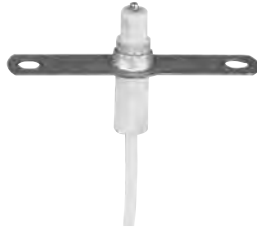

### 1801B182

Igniter, Top  
Burner Spark



Sealed burner type

### 1805D94

Knob, Burner

Flush shaft



Generic replacement for older styles which are no longer available.

### 1805D97

Knob, Burner

1/2" extended shaft

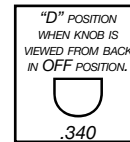

### 1805D141

Knob, Burner

3/16" extended shaft



Glossy white finish

### 1802A342

Knob, Thermostat

3/16" extended shaft

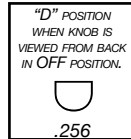

Glossy white finish

### 1802A343

Knob, Thermostat

1/8" extended shaft

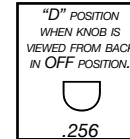

Glossy white finish

### 1805D137

Knob, Burner

3/16" extended shaft



Glossy black finish

### 1802A332

Knob, Thermostat

3/16" extended shaft



Glossy black finish

### 1802A333

Knob, Thermostat

1/8" extended shaft

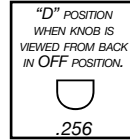

Glossy black finish

**CURRENT PRICING CAN BE FOUND ON OUR WEBSITE**

All logos, trademarks, part numbers, photos & illustrations are intended solely for identification. Items offered for sale are not represented to be manufactured by the company that built the original equipment.

PHONE: 800-843-0903 • FAX: 800-344-1848 • WEB: [www.pdqsupplyinc.com](http://www.pdqsupplyinc.com) • FB: [facebook.com/pdqsupplyinc](https://facebook.com/pdqsupplyinc)

**1805D135**

**Knob, Burner**

90° rotation  
5/16" extended shaft



Glossy black finish



**1805D136**

**Knob, Burner**

180° rotation  
5/16" extended shaft

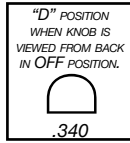

Glossy black finish



**1802A331**

**Knob, Thermostat**

Flush shaft

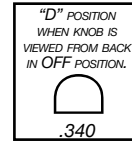

Glossy black finish



**1805D130**

**Knob, Burner**

180° rotation  
5/16" extended shaft



**1805D129**

**Knob, Burner**

90° rotation  
5/16" extended shaft

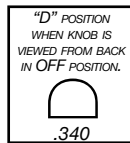

**1802A248**

**Knob, Thermostat**

Flush shaft

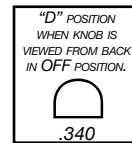

**1802A330**

**Knob, Thermostat**

Flush shaft

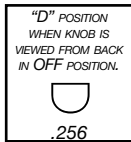

**1802A247**

**Knob, Thermostat**

Flush shaft

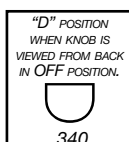

**1802A295**

**Knob, Thermostat**

Flush shaft

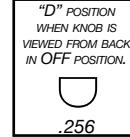

Used with thermostat #1802A302

**1801B142**

**Module, Spark**

(factory i.d. #7087)  
(factory i.d. #DG189)  
2+1

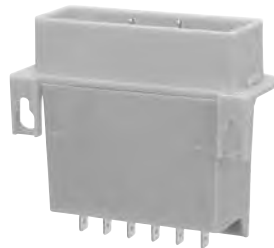

Has (6) .250" & (3) .110" male terminals

**1801B105**

**Module, Spark**

(factory i.d. #6513)  
(factory i.d. #977)  
2+1



Has (6) .250" & (3) .110" male terminals

**1801B173** 2+1

(factory i.d. #6549)  
(6) .250" & (3) .110" male terminals

**1801B179** 4+1

(factory i.d. #6547) (shown)  
(6) .250" & (5) .110" male terminals

**Module, Spark**



**1801B183** 4+0

(factory i.d. #46328041-001)  
(2) .250" & (4) .110" male terminals

**1801B184** 2+0

(factory i.d. #26328041-001)  
(2) .250" & (2) .110" male terminals  
Used on type-7 models  
with glow ignition

**Module, Spark**



CURRENT PRICING CAN BE FOUND ON OUR WEBSITE

All logos, trademarks, part numbers, photos & illustrations are intended solely for identification. Items offered for sale are not represented to be manufactured by the company that built the original equipment.

PHONE: 800-843-0903 • FAX: 800-344-1848 • WEB: www.pdqsupplyinc.com • FB: facebook.com/pdqsupplyinc

### 1805E112

Pan, Drip  
7" dia



No longer available from the OEM.  
Originals still available from PDQ.

### 1802E48

Pilot, Oven  
Standing Pilot  
R.H. mounting

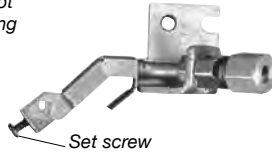

Used with safety valve  
#1802A150, #1802A239

### 1802E67

Pilot, Oven  
Standing Pilot  
L.H. mounting

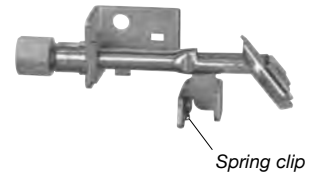

### 1802E68

Pilot, Oven  
Spark Ignition  
L.H. mounting

Has bracket  
for mounting  
oven spark ignitor

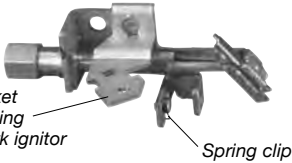

Used with safety valve  
#1802A205 & #1802A206

### 1802E76

Assembly,  
Oven Pilot  
Spark Ignition



Both are used with thermostat #1802A319

### 1802A326

Thermocouple Only



### 1801L24

Regulator, Pressure  
(factory i.d. #4670G0032)  
1/2" NPT inlet x 1/2" NPT outlet  
4"/10" convertible  
Set at 10" LP gas



### 1801L33

Regulator, Pressure  
(factory i.d. #4670G0031)  
1/2" NPT inlet x 1/2" NPT outlet  
4"/10" convertible  
Set at 4" natural gas



### 1801A152

Light red insert

### 1801A153

Light green insert

### 1801A165

Dark blue insert

Switch,  
Burner Spark (top)

Standard "D" inserts (.340")

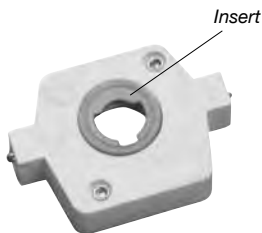

### 1802A207

Black insert

### 1802A223

White insert

Switch, Oven Spark

Standard "D" inserts (.340")

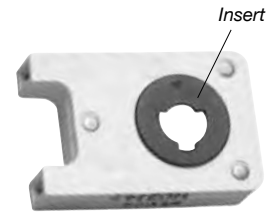

### 1802A302

Thermostat, Oven

(factory i.d. #6460G0018)

(factory i.d. #6460G0014)

120V, 2-wire



Used on type 7 models with glow ignition.  
Used with safety valve #1802A301 and oven ignitor #1802A300

### 1802A305

Thermostat, Oven

(factory i.d. #E/G5 275-3471-00)

125V, 2-wire



Has (2) .250" male terminals  
Used on type 7 models with glow ignition  
Used with oven knobs #1802A333, #1802A343

CURRENT PRICING CAN BE FOUND ON OUR WEBSITE

All logos, trademarks, part numbers, photos & illustrations are intended solely for identification. Items offered for sale are not represented to be manufactured by the company that built the original equipment.

PHONE: 800-843-0903 • FAX: 800-344-1848 • WEB: [www.pdqsupplyinc.com](http://www.pdqsupplyinc.com) • FB: [facebook.com/pdqsupplyinc](https://facebook.com/pdqsupplyinc)

**1802A241**

**Thermostat, Oven**

(factory i.d. #ELO)  
Standing pilot  
Spring clip mount  
1-1/8" shaft length

Bolts go through the thermostat & thread into spring clips on the manifold pipe



Includes fittings shown  
Red "O" Ring on inlet of thermostat body

**1802A290**

**Thermostat, Oven**

(factory i.d. #5362G0013)  
3 Outlets • 1-1/4" shaft length  
Standing pilot  
Bolt thru mount

Bolts go thru the manifold pipe and thread directly into thermostat

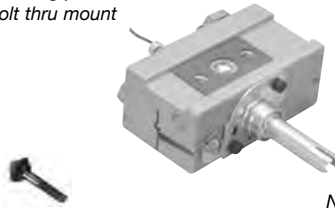

Bolts - #1804A62  
Flange Nipple - None

Newer style with full on-off cycling broil

**1802A291**

**Thermostat, Oven**

(factory i.d. #5396G0017)  
2 Outlets • 1-1/4" shaft length  
spark ignition  
bolt thru mount

Bolts go thru the manifold pipe and thread directly into thermostat

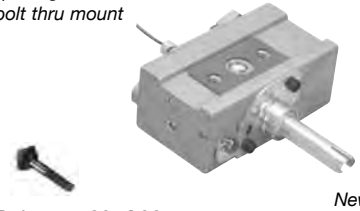

Bolts - #1804A62  
Flange Nipple - None

Newer style with full on-off cycling broil

**1802A319**

**Thermostat, Oven**

1 Outlet • 7/8" shaft length  
Standing pilot  
Saddle mount

Bolts go thru the manifold pipe and thread directly into thermostat

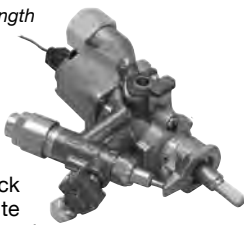

Is used with...

- 1802A332 Knob black
- 1802A342 Knob white
- 1802A326 Thermocouple
- 1802E76 Pilot, Oven
- 1802A323 Mount, Thermostat

**1801A133**

**1801A134**

**Valve, Burner**

90° shaft rotation

No longer available from the OEM. Originals still available from PDQ.

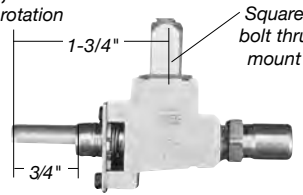

180022E01 Bolt & Gasket

**1801A157**

90° shaft rotation

**1801A159**

180° shaft rotation

**Valve, Burner**

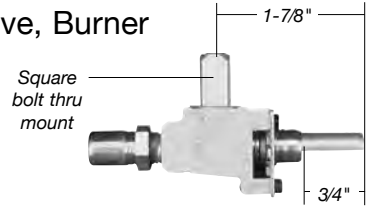

180022E01 Bolt & Gasket

**1801A166**

**Valve, Burner**

90° shaft rotation  
Vertical mounting

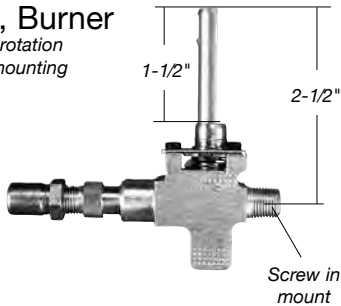

Used on gas cooktops

**1801A203**

**Valve, Burner**

270° shaft rotation

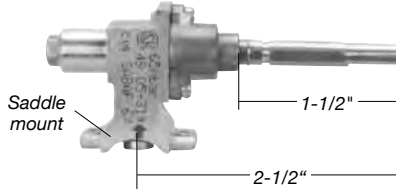

Saddle & screw included

1801A204 Saddle  
1801A205 Screw

**1802A206**

Natural gas

**1802A205**

L.P. gas

**Valve, Safety**

3/8" inlet

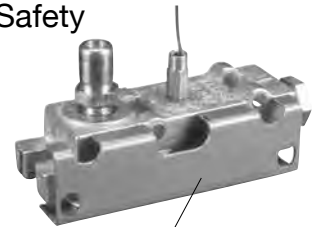

Includes mounting bracket

**1802A301**

**Valve, Safety**

3.03-3.3 VAC  
3.3-3.6 amp

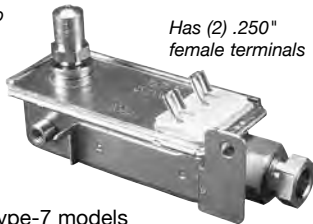

Has (2) .250" female terminals

Used on type-7 models with glow ignition  
Used with thermostat #1802A302 and oven ignitor #1802A300

**1802A338**

**Valve, Safety**

(3.03-3.3 VAC) • (3.3-3.6 amp)

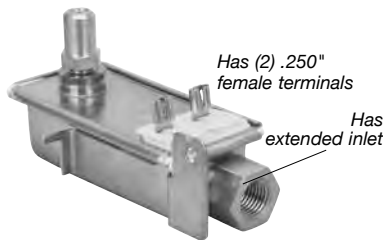

Has (2) .250" female terminals

Has extended inlet

Used on glow ignition ranges

**1802A298**

**Valve, Safety**

(3.03-3.3 VAC) • (3.3-3.6 amp)

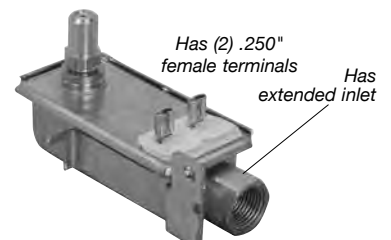

Has (2) .250" female terminals

Has extended inlet

Used on glow ignition wall ovens

CURRENT PRICING CAN BE FOUND ON OUR WEBSITE

All logos, trademarks, part numbers, photos & illustrations are intended solely for identification. Items offered for sale are not represented to be manufactured by the company that built the original equipment.

PHONE: 800-843-0903 • FAX: 800-344-1848 • WEB: www.pdqsupplyinc.com • FB: facebook.com/pdqsupplyinc



ELECTRIC RANGE PARTS

**1841L28A**  
Block, Terminal  
1" wide block

Molex Style

Includes:  
block, 6" lead wires with stripped ends,  
(2) heat shrink,  
(2) wire nuts &  
(2) top clips

**1841L30**  
Block, Terminal  
1-1/16" wide block

Molex Style

Complete terminal block assembly  
(70" lead wires with .250" female crimped flag terminals)

**1841L57A**  
Block, Terminal  
1-1/8" wide block

Amp Style

Complete terminal block assembly  
45" lead wires with .250" female flag terminal ends

**1842E36**  
Element, Bake  
2600 Watts  
240 Volts

.250" male terminal push-in connection

Used on 30" ranges

**1842E37**  
Element, Bake  
2000/1500 Watts  
240/208 Volts

.250" male terminal push-in connection

Used on 20", 24" 30" & 36" ranges

**1842E34**  
Element, Broil  
2500 Watts  
240 Volts

.250" male terminal push-in connection

Used on 20", 24" & 36" ranges

**1841M36**  
Element, Surface  
6", 3-turn  
940W@208V • 1250W@240V

"Delta" bracket

**1841M37**  
Element, Surface  
8", 4-turn  
1580W@208V • 2100W@240V

"Delta" bracket

**1841M36Y**  
Element, Surface  
6", 3-turn  
940W@208V • 1250W@240V

"Y" bracket

**1841M37Y**  
Element, Surface  
8", 4-turn  
1580W@208V • 2100W@240V

"Y" bracket

**1845D33**  
Knob, Infinite  
Flush shaft

"D" POSITION  
WHEN KNOB IS  
VIEWED FROM BACK  
IN OFF POSITION.

**1842A40**  
Knob, Thermostat  
Flush shaft

"D" POSITION  
WHEN KNOB IS  
VIEWED FROM BACK  
IN OFF POSITION.

**1842A56**  
Knob, Thermostat  
Flush shaft

"D" POSITION  
WHEN KNOB IS  
VIEWED FROM BACK  
IN OFF POSITION.

CURRENT PRICING CAN BE FOUND ON OUR WEBSITE

All logos, trademarks, part numbers, photos & illustrations are intended solely for identification. Items offered for sale are not represented to be manufactured by the company that built the original equipment.

PHONE: 800-843-0903 • FAX: 800-344-1848 • WEB: [www.pdqsupplyinc.com](http://www.pdqsupplyinc.com) • FB: [facebook.com/pdqsupplyinc](https://facebook.com/pdqsupplyinc)

**1845D40**

Knob, Infinite  
Flush shaft

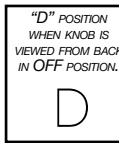
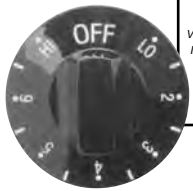

Glossy black finish

**1842A58**

Knob, Thermostat  
Flush shaft

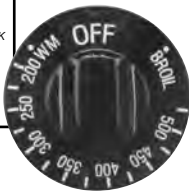

**1845D41**

Knob, Infinite  
Flush shaft

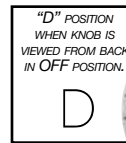

Glossy white finish

**1842A60**

Knob, Thermostat  
Flush shaft

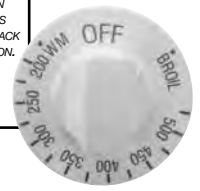

**1845G63**

12" lead wires with  
(2) .250" male / .250" female piggy back terminals

(shown)

Both include  
replacement red lens

**1845G66**

9" lead wires with (1) .250" female flag terminal  
and (1) .250" male / .250" female piggy back terminal

Light, Indicator



**REDLENS**

Red lens only (order # is REDLENS)

**1841N29**

Pan, Drip  
6"



Has Slot

Has small holes

**1841N30**

Pan, Drip  
8"



**1841L23**

Switch, Infinite  
(factory i.d. #INF240P-714)  
15 amp

Universal for  
6" and 8" elements

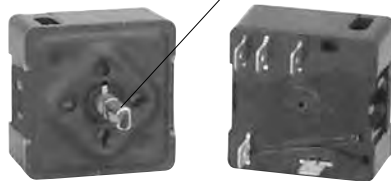

Spring clip  
on shaft

Voltage sensing type

**1841L61**

(factory i.d. #NL831473)  
Used with 6" elements  
5.2 - 6.25 amps

**1841L62**

(factory i.d. #NL832458)  
Used with 8" elements  
8.8 - 10.8 amps

Switch, Infinite



Current sensing type

**1842A18**

Thermostat, Oven  
(factory i.d. #6703G0007)  
4 Terminals  
240V • 15 amp  
Single pole, variable broil

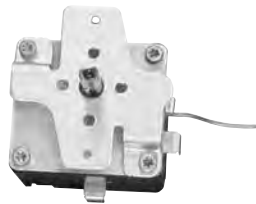

Brown subs this part to a #1842A57.  
"Originals" are still available from PDQ while supplies last.

**1842A54**

Thermostat, Oven  
(factory i.d. #6713G0021)  
6 Terminals  
240V • 15 amp  
Double pole variable broil

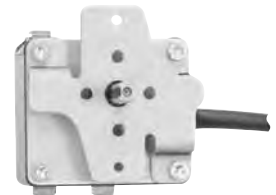

Brown subs this part to kit #1842A57.  
"Originals" are still available from PDQ while supplies last.

**1842A57**

Thermostat, Oven Kit  
(factory i.d. #275-3492-00)  
(factory i.d. #275-3509-00)  
7 Terminals  
125/250V • 22 amp  
Kit includes knob

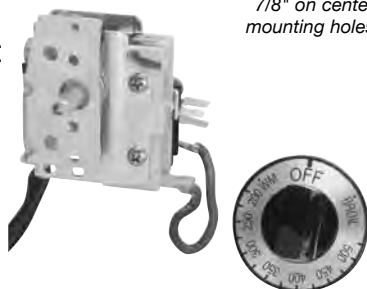

7/8" on center  
mounting holes

**1842A56**

Knob, Thermostat

**1842A59**

Thermostat, Oven  
(factory i.d. #275-3493-00)  
7 Terminals  
125/250V • 22 amp

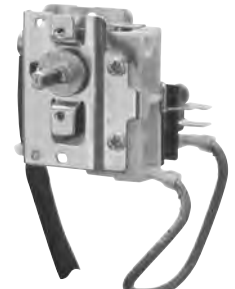

1-1/2" on center mounting holes  
for ranges built after August 2003.

CURRENT PRICING CAN BE FOUND ON OUR WEBSITE

All logos, trademarks, part numbers, photos & illustrations are intended solely for identification. Items offered for sale are not represented to be manufactured by the company that built the original equipment.

PHONE: 800-843-0903 • FAX: 800-344-1848 • WEB: www.pdqsupplyinc.com • FB: facebook.com/pdqsupplyinc

MISC. RANGE PARTS

**7572**  
Backguard  
White



For 30" models  
Replaces #5923, no endcaps required

**1804C66**  
Clip, Diastat



Used for mounting oven temp. bulb to oven cavity

**1805F222**  
Left (shown)  
**1805F223**  
Right

No longer available from the OEM. Originals still available from PDQ.

Endcap, Backguard

Used on 24", 30" & 36" ranges



Black finish

**1803D11**  
Rivet



**1805F224** No longer available from the OEM. Originals still available from PDQ.  
Left

**1805F225**  
Right (shown)  
Endcap, Backguard

Used on 20" gas ranges only  
High temperature resistant

Black Finish



**1803D11**  
Rivet



**1802144** (A)  
11-1/2" overall length

**1802145** (A)  
16" overall length

**1802156** (B)  
13-3/8" overall length

**1802165** (A)  
17-1/4" overall length

**1802166** (A)  
18-7/8" overall length

**1802167** (A)  
21-3/8" overall length

**1802168** (A)  
14-5/8" overall length

Gasket, Oven Door  
"Stretch Seals"



(A)



(B)

**1805C52**  
Handle, Broiler Door  
9" overall length  
8" on center holes



**1805C59**  
Handle, Oven Door  
16-1/2" overall length  
8" & 12" on center holes  
Black



**4811**  
Hinge, Oven Body  
Left

**4812**  
Hinge, Oven Body  
Right



Used on 24", 30" & 36" gas & electric ranges  
Uses cotter pin #1804E28 & hinge pin #1803C19

**6631**  
Hinge, Oven Door  
Reversible left or right



Uses cotter pin #1804E28 & hinge pin #1803C19  
Reversible style hinge, used on lift-off door models: 24" models thru type 35, 30" models thru type 45, & 36" models thru type 30

**6875** Right  
**6876** Left  
Hinge, Oven Door

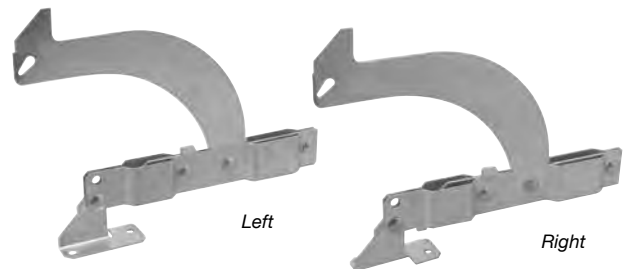

Left

Right

Newest style hinge assembly used on 24" models - type 36 & up, 30" models - type 46 & up, & used on 36" models - type 31 & up.

CURRENT PRICING CAN BE FOUND ON OUR WEBSITE

All logos, trademarks, part numbers, photos & illustrations are intended solely for identification. Items offered for sale are not represented to be manufactured by the company that built the original equipment.

PHONE: 800-843-0903 • FAX: 800-344-1848 • WEB: www.pdqsupplyinc.com • FB: facebook.com/pdqsupplyinc



**6724**  
Kit, Anti-Tip  
4-3/4" x 2-1/8"



Kit includes bracket and (2) screws

**4115**  
Pan, Broiler  
11-3/4" wide x 14-3/8" deep

**5795**  
Grid, Broiler  
10" wide x 13" deep

Used on electric range models

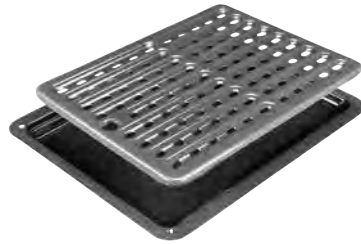

Pan & grid are not sold as a set  
Must be ordered separately

**5686**  
Pan, Broiler  
13-3/4" wide x 17-5/8" deep

**5687**  
Shield, Grease  
12" wide x 3-1/2" deep

Old style - 1 piece broiler pan/grid



Grease shield

Pan & shield are not sold as a set  
Must be ordered separately

**1804E28**  
Pin, Cotter

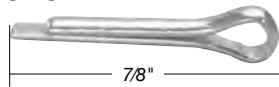

**1803C19**  
Pin, Hinge



Used with hinges #4811, #4812 & #6631

**1802G35**  
Rack, Oven  
23-3/4" wide x 15-3/4" deep

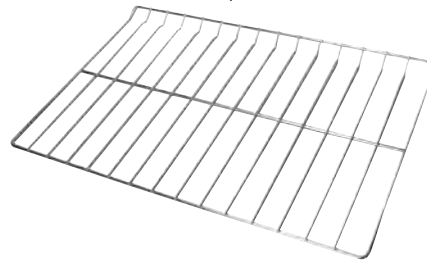

Used on 30" ranges

**1802G38**  
Rack, Oven  
15-3/4" wide x 15-3/4" deep



Used on 20" ranges

**1802G39**  
Rack, Oven  
18-3/4" wide x 15-3/4" deep

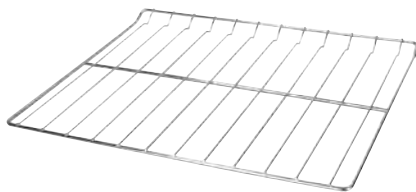

Used on 24" & 36" ranges

**1804D5**  
Spacer, Handle  
White  
5/8" diameter  
1/4" thickness



**1803A46**  
Spring, Oven Door  
5-1/4" overall length



New style used on 24" ranges type 36 & up  
New style used on 30" ranges type 46 & up

**6268** 20" (shown)  
**6272** 24"  
**6273** 30"  
Top, Main - Gas  
White

Used on gas ranges



CURRENT PRICING CAN BE FOUND ON OUR WEBSITE

All logos, trademarks, part numbers, photos & illustrations are intended solely for identification. Items offered for sale are not represented to be manufactured by the company that built the original equipment.

PHONE: 800-843-0903 • FAX: 800-344-1848 • WEB: [www.pdqsupplyinc.com](http://www.pdqsupplyinc.com) • FB: [facebook.com/pdqsupplyinc](https://facebook.com/pdqsupplyinc)