

GAS RANGE PARTS

**WB16K10070**  
Burner, Small  
5K



— sold separately —

**WB29K10002**  
Cap, Burner  
Small - gray  
2-1/2" dia.



**WB16K10055**  
Burner, Medium  
9.5K



— sold separately —

**WB29K10004**  
Cap, Burner  
Medium - gray  
3-1/4" dia.



**WB16K10056**  
Burner, Large  
12K



— sold separately —

**WB29K10007**  
Cap, Burner  
Large - gray  
3-1/2" dia.



**WB16K10003** burner head porting  
Burner, Double  
STRAIGHT SLOTS

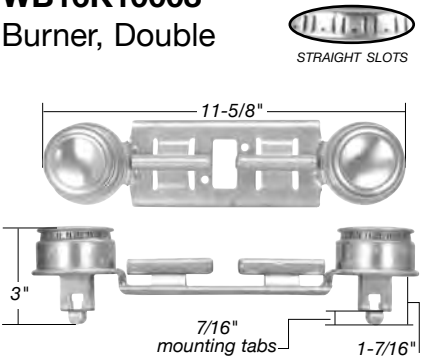

11-5/8"  
3"  
7/16" mounting tabs  
1-7/16"

**WB16K10026** burner head porting  
Burner, Double  
STRAIGHT SLOTS

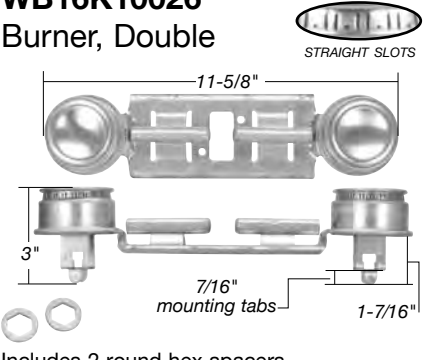

11-5/8"  
3"  
7/16" mounting tabs  
1-7/16"  
Includes 2 round hex spacers

**WB29K17** burner head porting  
Burner, Double  
STRAIGHT SLOTS

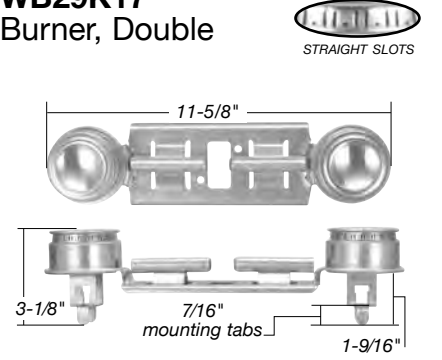

11-5/8"  
3-1/8"  
7/16" mounting tabs  
1-9/16"

**WB28X112** Burner, Front  
9"  
4-1/8"

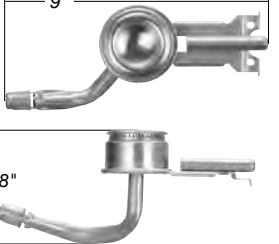

burner head porting  
SLOTS

**WB28X111** Burner, Rear  
15-3/4"  
3-1/2"

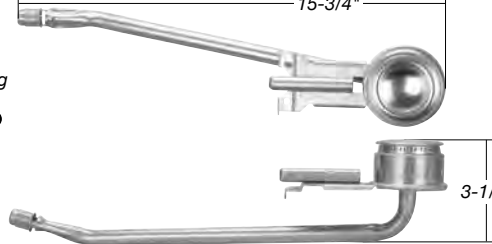

**WB28X5047** Burner, Front  
9-3/8"  
3-1/4"

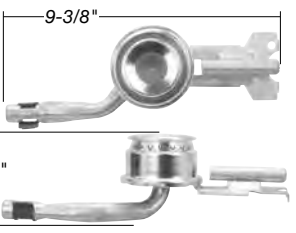

burner head porting  
SLOTS

**WB28X5049** Burner, Rear  
15-3/8"  
4-1/2"

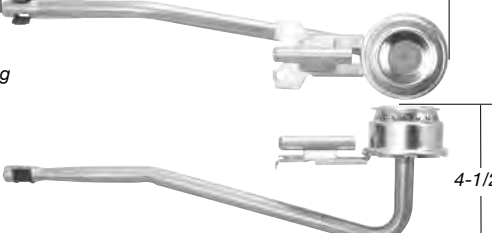

**WB16K10043**  
Burner, Oven Kit  
Includes igniter #WB13K21 & air shutter

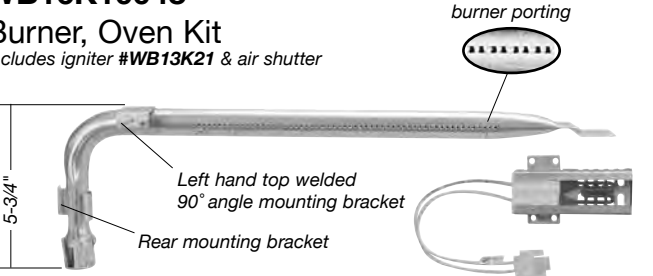

burner porting

5-3/4"  
Left hand top welded 90° angle mounting bracket  
Rear mounting bracket

**WB16K10061**  
Burner, Oven Kit  
Includes pilot & thermocouple #WB19K10008



5-3/4"  
Rear mounting bracket

Used with oven t-stat #WB20K10013

CURRENT PRICING CAN BE FOUND ON OUR WEBSITE

All logos, trademarks, part numbers, photos & illustrations are intended solely for identification. Items offered for sale are not represented to be manufactured by the company that built the original equipment.

PHONE: 800-843-0903 • FAX: 800-344-1848 • WEB: [www.pdqsupplyinc.com](http://www.pdqsupplyinc.com) • FB: [facebook.com/pdqsupplyinc](https://www.facebook.com/pdqsupplyinc)

**WB13K10003**  
Electrode,  
Sealed Burner

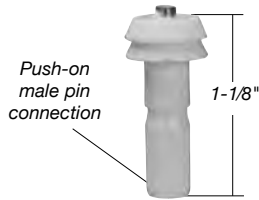

**WB1K10112**  
Clip *sold separately*



**WB13K10014**  
Electrode,  
Sealed Burner

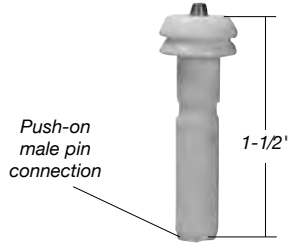

**WB13K18**  
Electrode,  
Sealed Burner

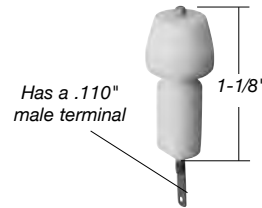

**WB1K56**  
Clip *sold separately*



**WB32X5110**  
Grate  
6-5/8" diameter



**WB31K6**  
Grate  
8-1/2" x 8-1/2"  
1" height

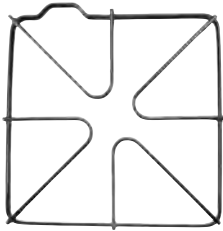

**WB31K7**  
Grate  
8-1/2" x 8-1/2"  
1-1/8" height

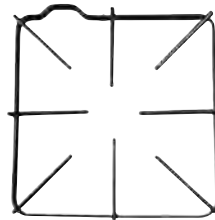

Used with drip pans  
#WB49K3 & #WB49K5

**WB31K10012**  
Grate  
8-1/2" x 8-1/2"  
1-1/4" height

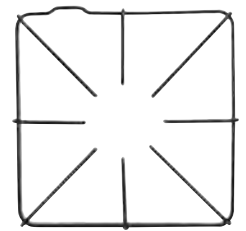

**WB19K5**  
Harness, Dual Top Pilot  
20" overall length  
Has 1/4" sleeve

**WB2K21**  
Cup, Pilot *threaded*



**WB1X1155**  
Bolt, Mounting

**WB2X8550**  
Harness, Dual Top Pilot  
19-3/4" overall length  
Used on 36" models

**3392**  
Shield, Pilot (2) included



**WB2X10016**  
Igniter, Oven Glow  
Flat type

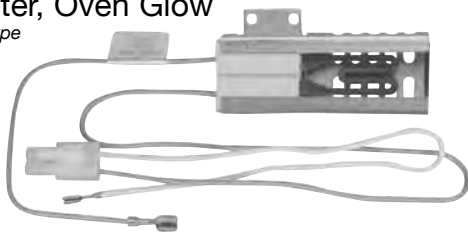

Includes (2) wire nuts. Has (1) 15" lead to disconnect block & an additional 12" lead with a .187" female terminal. Has (1) 8" lead with a .250" female terminal.

**WB2X9998**  
Igniter, Oven Glow  
(factory i.d. #223C3381G005)  
17" lead wires with stripped ends  
Flat type

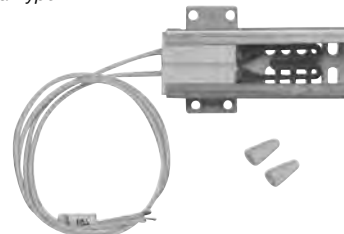

**WB13K21**  
Igniter, Oven Glow  
(factory i.d. #223C3381G001)  
(factory i.d. #223C3381G003)  
7" lead wires  
Flat type

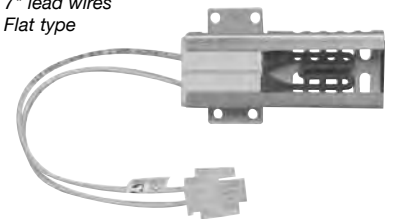

Has quick disconnect attached

MORE

CURRENT PRICING CAN BE FOUND ON OUR WEBSITE

All logos, trademarks, part numbers, photos & illustrations are intended solely for identification. Items offered for sale are not represented to be manufactured by the company that built the original equipment.

PHONE: 800-843-0903 • FAX: 800-344-1848 • WEB: [www.pdqsupplyinc.com](http://www.pdqsupplyinc.com) • FB: [facebook.com/pdqsupplyinc](https://facebook.com/pdqsupplyinc)

GAS RANGE PARTS

## WB2X7934

Igniter, Oven Glow

8" lead wires  
Flat type

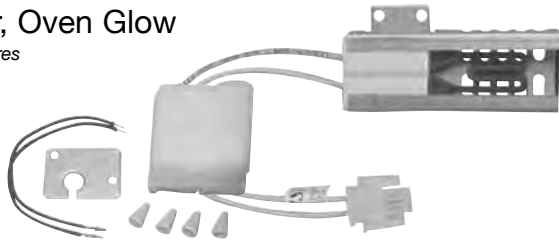

Has quick disconnect attached

## WB2X9154

Igniter, Oven Glow

(factory i.d. #WB00X6640)  
8-1/2" lead wires with stripped ends  
Round "Carborundum" type



## WB13K10023

Igniter, Top Burner Spark

46" lead wire

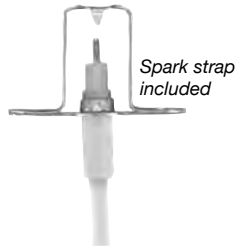

Has a .187" female spade terminal

## WB19K20

Igniter, Top Burner Spark

29" lead wire

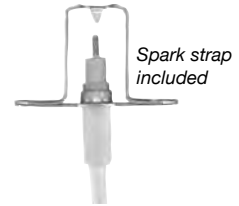

Has a .187" female spade terminal  
Used with spark modules

#WB20K5037, #WB13K10017, #WB13K25

## WB3K10007

Knob, Burner

5/16" extended shaft  
Plain knob - no graphics



"D" POSITION  
WHEN KNOB IS  
VIEWED FROM BACK  
IN OFF POSITION.  
D  
.256

## WB3K10006

Knob, Thermostat

1/2" extended shaft  
405° at 6:00



"D" POSITION  
WHEN KNOB IS  
VIEWED FROM BACK  
IN OFF POSITION.  
D  
.340

## WB3K10008

Knob, Thermostat

1/2" extended shaft  
350° at 6:00



"D" POSITION  
WHEN KNOB IS  
VIEWED FROM BACK  
IN OFF POSITION.  
D  
.256

## WB36K10126

Knob, Burner

5/16" extended shaft  
140° rotation



"D" POSITION  
WHEN KNOB IS  
VIEWED FROM BACK  
IN OFF POSITION.  
D  
.256

## WB3K10048

Knob, Thermostat

1/2" extended shaft  
350° at 6:00



"D" POSITION  
WHEN KNOB IS  
VIEWED FROM BACK  
IN OFF POSITION.  
D  
.256

## WB3K10061

Knob, Thermostat

1/2" extended shaft  
405° at 6:00



"D" POSITION  
WHEN KNOB IS  
VIEWED FROM BACK  
IN OFF POSITION.  
D  
.340

## WB3K10035

Knob, Burner

5/16" extended shaft  
Plain knob - no graphics



"D" POSITION  
WHEN KNOB IS  
VIEWED FROM BACK  
IN OFF POSITION.  
D  
.256

## WB3K10159

Knob, Thermostat

1/2" extended shaft  
Approx. 450° at 6:00



"D" POSITION  
WHEN KNOB IS  
VIEWED FROM BACK  
IN OFF POSITION.  
D  
.256

Used on standing pilot ignition ranges with a thermocouple  
Used with oven thermostat #WB20K10003

## WB3K10037

Knob, Thermostat

1/2" extended shaft  
Approx. 340° at 6:00



"D" POSITION  
WHEN KNOB IS  
VIEWED FROM BACK  
IN OFF POSITION.  
D  
.256

Used on electric ignition ranges

CURRENT PRICING CAN BE FOUND ON OUR WEBSITE

All logos, trademarks, part numbers, photos & illustrations are intended solely for identification. Items offered for sale are not represented to be manufactured by the company that built the original equipment.

PHONE: 800-843-0903 • FAX: 800-344-1848 • WEB: www.pdqsupplyinc.com • FB: facebook.com/pdqsupplyinc

**WB3K10034**  
Knob, Burner  
5/16" extended shaft



"D" POSITION  
WHEN KNOB IS  
VIEWED FROM BACK  
IN OFF POSITION.  
 .256

**WB3K10244**  
Knob, Thermostat  
1/2" extended shaft  
Approx. 450° at 6:00



"D" POSITION  
WHEN KNOB IS  
VIEWED FROM BACK  
IN OFF POSITION.  
 .256

Used on standing pilot ranges

**WB3K10036**  
Knob, Thermostat  
1/2" extended shaft  
Approx. 450° at 6:00



"D" POSITION  
WHEN KNOB IS  
VIEWED FROM BACK  
IN OFF POSITION.  
 .256

Used on electric ignition ranges

**WB3K10141**  
Knob, Burner  
5/16" extended shaft



"D" POSITION  
WHEN KNOB IS  
VIEWED FROM BACK  
IN OFF POSITION.  
 .256

**WB3K10142**  
Knob, Thermostat  
1/2" extended shaft  
Approx. 330° at 6:00



**WB3K10143**  
Knob, Burner  
5/16" extended shaft



"D" POSITION  
WHEN KNOB IS  
VIEWED FROM BACK  
IN OFF POSITION.  
 .256

**WB3K10144**  
Knob, Thermostat  
1/2" extended shaft  
Approx. 330° at 6:00



**WB3X745**  
Knob, Burner  
Flush shaft



"D" POSITION  
WHEN KNOB IS  
VIEWED FROM BACK  
IN OFF POSITION.  
 .340

**WB3X648**  
Knob, Thermostat  
Flush shaft  
Approx 415° at 6:00



**WB3X5857**  
Knob, Burner  
5/16" extended shaft



"D" POSITION  
WHEN KNOB IS  
VIEWED FROM BACK  
IN OFF POSITION.  
 .340

**WB3X5856**  
Knob, Thermostat  
Flush shaft  
Approx 410° at 6:00



**WB3K100**  
Knob, Burner  
5/16" extended shaft  
106° rotation



"D" POSITION  
WHEN KNOB IS  
VIEWED FROM BACK  
IN OFF POSITION.  
 .256

**WB3K23**  
Knob, Thermostat  
1/2" extended shaft  
Approx. 410° at 6:00



"D" POSITION  
WHEN KNOB IS  
VIEWED FROM BACK  
IN OFF POSITION.  
 .340

**WB3K60**  
Knob, Thermostat  
3/8" extended shaft  
Approx. 350° at 6:00



"D" POSITION  
WHEN KNOB IS  
VIEWED FROM BACK  
IN OFF POSITION.  
 .256

Used on electric ignition ranges

**WB13K25**  
Module, Spark  
(factory i.d. #223C3201P002)  
(factory i.d. #6544)  
Snap-in mounting  
4+0



Has (2) .250" male terminals  
& (4) .187" male terminals

**WB13K10017**  
Module, Spark  
(factory i.d. #223C4319P001)  
Snap-in mounting  
2+0



Has (2) .250" and  
(2) .187" male terminals

**WB13K10018**  
Module, Spark  
(factory i.d. #223C4319P002)  
4+0



Has (2) .250" and  
(4) .187" male terminals

CURRENT PRICING CAN BE FOUND ON OUR WEBSITE

All logos, trademarks, part numbers, photos & illustrations are intended solely for identification. Items offered for sale are not represented to be manufactured by the company that built the original equipment.

GAS RANGE PARTS

**WB13K10**  
Module, Spark  
*(factory i.d. #6520G0601)*  
2+0



Has (2) .250" male terminals  
and (2) .187" male terminals

**WB13K10028**  
Module, Spark  
*(factory i.d. #223C4955P001)*  
2+0

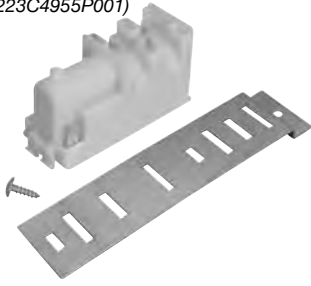

Has (2) .250" and (2) .187" male terminals

**WB13K10029**  
Module, Spark  
*(factory i.d. #223C4955P002)*  
4+0

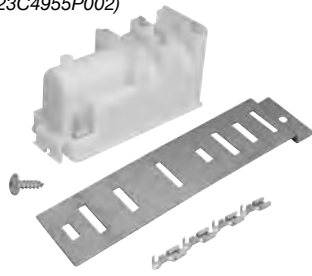

Has (2) .250" and (4) .187" male terminals

**WB20X93**  
Module, Spark  
*(factory i.d. #7087)*  
*(factory i.d. #DG189)*  
2+1



Has (6) .250" and (3) .110" male terminals

**WB20X104**  
Module, Spark  
*(factory i.d. #DG189)*  
*(factory i.d. #7087)*  
2+1



Has (6) .250" and (3) .110" male terminals

**WB20X107**  
Module, Spark  
*(factory i.d. #6520G0301, #320990)*  
2+0

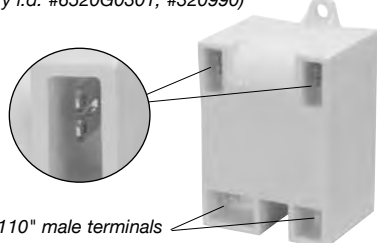

.110" male terminals

Universal split terminal design suitable for .110", .187" & .250" push on wiring

**WB20K5037**  
Module, Spark  
*(factory i.d. #223C3200P002)*  
*(factory i.d. #6545)*  
Snap-in mounting  
2+0



Has (2) .250" male terminals  
& (2) .187" male terminals

**WB20X10010**  
Module, Spark  
*(factory i.d. #6549)*  
2+1



Has (6) .250" and (3) .110" male terminals

**WB21X5265**  
Module, Spark  
*(factory i.d. #Y54052)*  
2+0



Has (4) .250" male terminals

**WB2X8544**  
Pilot, Oven  
Standing pilot/spark ignition  
L.H. mounting



Spring clip

Replaces oven pilot #WB2X8543  
Used w/ oven spark igniter #WB21X5351

**WB19K10008**  
Assembly, Pilot & Thermocouple

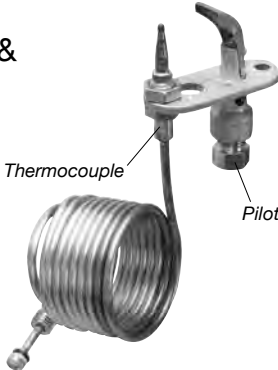

Thermocouple  
Pilot

**WB19K10028**  
Pilot

**WB19K10025**  
Thermocouple

Are also sold separately

**WB19K26**  
Regulator, Pressure  
*(factory i.d. #205C1243P001)*  
*(factory i.d. #4670G0057)*  
1/2" NPT inlet x 1/2" NPT outlet  
5"/10" convertible  
Set at 5" natural gas



Includes bushing to convert regulator to 1/2" x 3/8"

CURRENT PRICING CAN BE FOUND ON OUR WEBSITE

All logos, trademarks, part numbers, photos & illustrations are intended solely for identification. Items offered for sale are not represented to be manufactured by the company that built the original equipment.

PHONE: 800-843-0903 • FAX: 800-344-1848 • WEB: [www.pdqsupplyinc.com](http://www.pdqsupplyinc.com) • FB: [facebook.com/pdqsupplyinc](https://facebook.com/pdqsupplyinc)



**WB19K10055**

**Regulator, Pressure**

(factory i.d. #222D396G001)  
1/2" NPT inlet x 3/8" NPT outlet  
4"/10" convertible  
Set at 4" natural gas

**NEW**

3/8" fine thread  
left hand  
tubing outlet



Has shut-off valve

**WB19K28**

**Regulator, Pressure**

(factory i.d. #223C3259G1)  
1/2" NPT inlet x 3/8" **fine thread tubing outlet**  
4"/10" convertible

3/8" fine thread tubing  
outlet with shut off



**WB19K10001**

**Regulator, Pressure**

(factory i.d. #223C3259G3)  
1/2" NPT inlet x 3/8" c.c. tubing outlet  
4"/10" convertible

3/8" fine thread tubing  
outlet with shut off



**WB21X5339**

**Regulator, Pressure**

(factory i.d. #110918)  
(factory i.d. #4670G0031)  
1/2" NPT inlet x 1/2" NPT outlet  
5"/10" convertible  
Set at 5" natural gas



**WB21X5301**

**Sensor, Oven**

Probe: 6" from tip to bracket  
Lead wires: 7" with quick disconnect

**NEW**



**WB24K1** Light Purple insert

**WB24X412** Dark Green insert

**WB21X5341** Light Red insert

**Switch, Burner Spark (top)**

Standard .340" dia. "D" insert

Insert



**WB24K10002**

**Switch, Burner Spark (top)**

Small .256" dia. "D" insert



Individual switch used with burner valve: #WB31K38, #WB21K39, #WB21K10009, #WB21K10050

**WB24K10002KIT**

**Assembly, Burner Spark Switch (top)**



Has attached plug-in disconnect

**WB24K16**

**Switch, Burner Spark (top)**

Dark Green insert  
Small .256" dia. "D" insert

Insert



Used with burner valve #WB21K19

**WB24K10017**

**Switch, Top Burner Spark (top)**

(factory i.d. #H30900-206)  
Small .256" dia. "D" insert

The OEM uses both of these styles of spark switch. You may receive either of these, depending on what they are shipping at the time of ordering. **You will NOT receive two spark switches.**

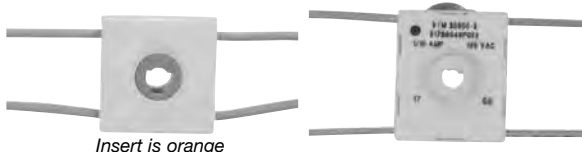

Insert is orange

Used with burner valve #WB21K10009 & #WB21K10050

**WB24K30**

**Switch, Burner Spark (top)**

(factory i.d. #25800-0)  
Small .256" dia. "D" insert

Insert



Used with burner valve #WB21K39

**WB24X411**

White insert

**WB21X5340**

Black insert

**Switch, Oven Spark**

Standard .340" dia. "D" insert

Insert



CURRENT PRICING CAN BE FOUND ON OUR WEBSITE

All logos, trademarks, part numbers, photos & illustrations are intended solely for identification. Items offered for sale are not represented to be manufactured by the company that built the original equipment.

PHONE: 800-843-0903 • FAX: 800-344-1848 • WEB: www.pdqsupplyinc.com • FB: facebook.com/pdqsupplyinc

GAS RANGE PARTS

### WB20K2

#### Thermostat, Oven

(factory i.d. #205C1279G001)  
(factory i.d. #5392G0012)  
2 outlets • 13/16" shaft length  
Standing pilot  
Bolt thru mount

Bolts go thru the manifold pipe and thread directly into thermostat



Bolts - #318478  
Flange Nipple - None



### WB20K10013

#### Thermostat, Oven

(factory i.d. #MTPP22300)  
3 outlets • 3/4" shaft length  
Millivolt  
Standing pilot  
Bolt thru mount

Bolts go thru the manifold pipe and thread directly into thermostat



Brass body

Used with thermostat knob #WB3K10159

### WB21X466

#### Thermostat, Oven

(factory i.d. #5396G0014, 5396G00015)  
2 outlets • 1-15/16" break-off shaft  
Spark ignition  
Bolt thru mount

Bolts go thru the manifold pipe and thread directly into thermostat



Has inverted flare main gas outlet

Bolts - #318478  
Flange Nipple - None



### WB21X471

#### Kit, Oven Thermostat

(factory i.d. #5392G3001, 5392G3002, 5392G3004, 5392G3005, 5392G0019)  
(factory i.d. #THS09)  
2 outlets • 1-15/16" break-off shafts  
Standing pilot  
Bolt thru mount

Bolts go thru the manifold pipe and thread directly into thermostat



Has inverted flare main gas outlet



Bolts - #318478  
Flange Nipple - None



### WB21X5342

#### Thermostat, Oven

(factory i.d. #5362G0001)  
(factory i.d. #5362G0013)  
3 outlets • 1-3/16" stem length  
Standing pilot  
Bolt thru mount

Bolts go thru the manifold pipe and thread directly into thermostat

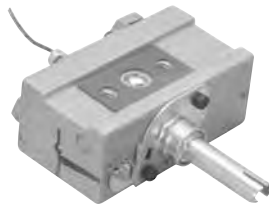

Bolts - #318478  
Flange Nipple - None



### WB21X5343

#### Thermostat, Oven

(factory i.d. #5396G0017)  
(factory i.d. #5396G0003)  
2 outlets • 1-1/4" shaft length  
Spark ignition  
Bolt thru mount

Bolts go thru the manifold pipe and thread directly into thermostat

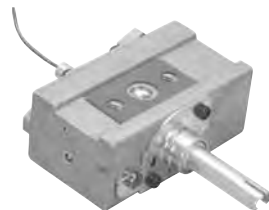

Bolts - #318478  
Flange Nipple - None



### WB20K5

#### Thermostat, Oven

(factory i.d. #164D2536P001)  
(factory i.d. #6440G0008)  
2 terminals • 7/8" shaft length  
120V, 5 amp, 2-wire



Used with knob #WB3K19  
Used with oven glow ignitor on gas ranges

### WB20K8

#### Thermostat, Oven

(factory i.d. #183D5463P001)  
(factory i.d. #6460G0003)  
2 terminals  
120V, 5 amp, 2-wire



### WB20K10023

#### Thermostat, Oven

(factory i.d. #223C3823P001)  
(factory i.d. #223C3823P002)  
2 terminals • 7/8" shaft length  
240V, 16 amps



Replaces #WB20K100008

### WB21X5273

#### Thermostat, Oven

(factory i.d. #EG-5, 275-3106-00)  
(factory i.d. #275-3140-05)  
120V, 2 wire



Used with oven glow ignitor #WB2X7934

CURRENT PRICING CAN BE FOUND ON OUR WEBSITE

All logos, trademarks, part numbers, photos & illustrations are intended solely for identification. Items offered for sale are not represented to be manufactured by the company that built the original equipment.

PHONE: 800-843-0903 • FAX: 800-344-1848 • WEB: [www.pdqsupplyinc.com](http://www.pdqsupplyinc.com) • FB: [facebook.com/pdqsupplyinc](https://www.facebook.com/pdqsupplyinc)

**WB2X5346**

Valve, Burner  
90° shaft rotation  
Square bolt thru mount

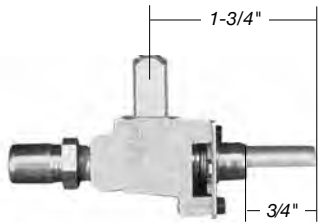

Bolt & gasket - #180022E01

**WB21K4**

Valve, Burner  
(factory i.d. #205C1901G001)  
106° shaft rotation  
Square bolt thru mount  
1/4" c.c. tubing outlet

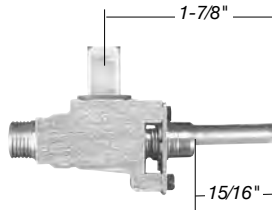

**WB21K20**

Valve, Mini Burner  
(factory i.d. #223C3369G002)  
(factory i.d. #223C3723G002)  
270° shaft rotation  
Square bolt thru mount  
1/4" c.c. tubing outlet

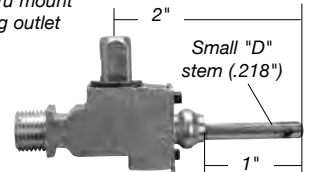

Bolt & gasket #WB1K83  
Used with spark switch #WB24K10003

**WB21K19**

Valve, Mini Burner  
(factory i.d. #205C2033G010)  
106° shaft rotation  
Square bolt thru mount  
1/4" c.c. tubing outlet

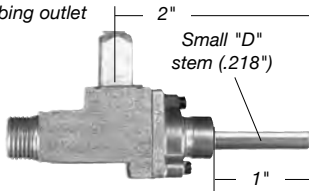

Bolt & gasket - #WB1K83  
Used with spark switch #WB24K16

**WB21K27**

Valve, Mini Brass Burner  
(factory i.d. #223C3250G007)  
270° shaft rotation  
Round bolt thru mount  
1/4" c.c. tubing outlet

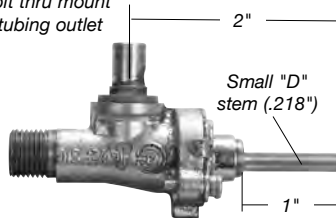

Used with spark switch #WB24K10003

**WB21K38**

Valve, Mini Burner  
(factory i.d. #223C3301G001)  
(factory i.d. #223C3724G001)  
140° shaft rotation  
Square bolt thru mount  
1/4" c.c. tubing outlet

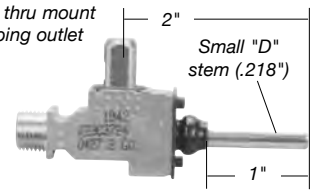

Bolt & gasket - #WB1K83  
Used with spark switch #WB24K10002

**WB21K39**

Valve, Mini Brass Burner  
(factory i.d. #223C3365G001)  
140° shaft rotation  
Round bolt thru mount  
1/4" c.c. tubing outlet

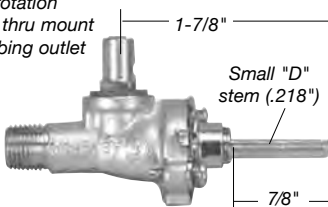

Bolt & gasket - #WB1K83  
Used with spark switch  
#WB24K10002 or #WB24K30

**WB21K10050**

Valve, Mini Brass Burner  
(factory i.d. #223C3708G001)  
(factory i.d. #4306P001)  
140° shaft rotation  
Round bolt thru mount  
1/4" c.c. tubing outlet

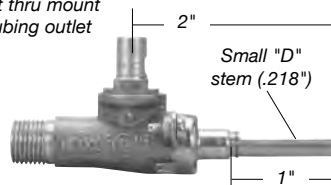

Used with spark switch #WB24K10017

**WB21X467**

Valve, Burner  
(factory i.d. #332001)  
106° shaft rotation  
Square bolt thru mount

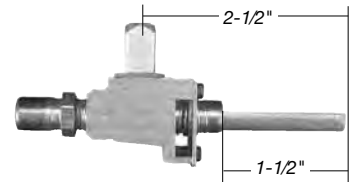

Bolt & gasket - #180022E01

**WB19K12**

Valve, Safety  
(factory i.d. #164D2575G001)  
3/8" inlet

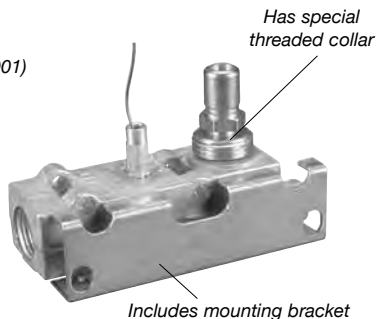

**WB19K13**

Valve, Safety  
3.3-4.0 VAC  
2.5-3.0 amp

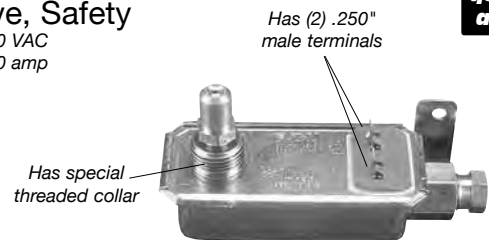

**Limited quantities available**

Used with round type ignitor #WB2X9154



GAS RANGE PARTS

## WB19K31

### Valve, Safety

(factory i.d.#183D5746G001)  
3.03-3.3 VAC  
3.3-3.6 amp

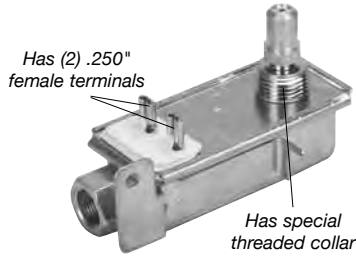

Used with oven ignitor #WB13K21

## WB21X10096

### Valve, Safety

3.3 VAC  
3.6 amp

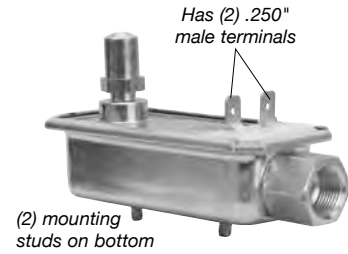

## WB21X474

### Valve, Safety

(factory i.d.#321795)  
(factory i.d.#5817H0057)  
3/8" inverted flare inlet

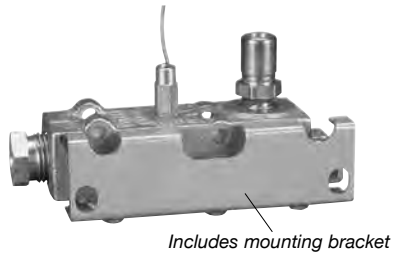

## WB21X5345

### Valve, Safety

(factory i.d.#5817G0004)  
3/8" inlet

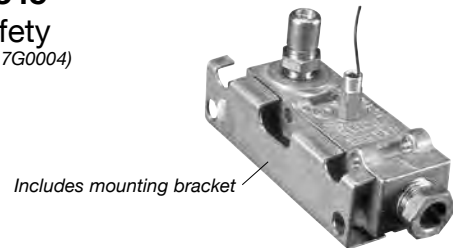

ELECTRIC RANGE PARTS

## WB2X8228

### Block, Terminal

25" lead wires  
1-1/8" wide block



Amp Style

## WB17X10006

### Block, Terminal Kit

68" lead wires  
1/8" wide block

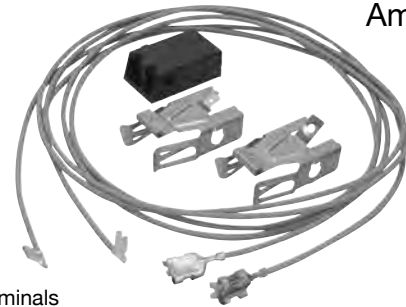

Amp Style

## WB17X210

### Block, Terminal

67" lead wires  
1-1/16" wide block



Molex Style

## WB17X5111

### Block, Terminal Kit

6" lead wires  
1-1/16" wide block

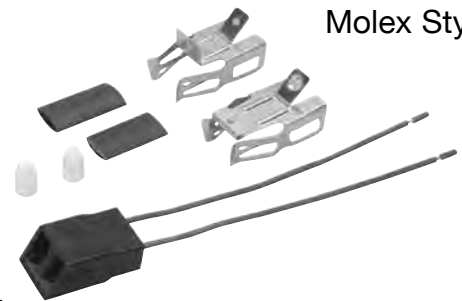

Molex Style

## WB44K10002

### Element, Broil

3410 watts  
240 volts

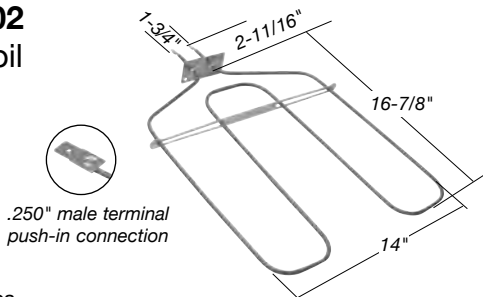

Used on 30" ranges

## WB44K10005

### Element, Bake

2585 watts  
240 volts

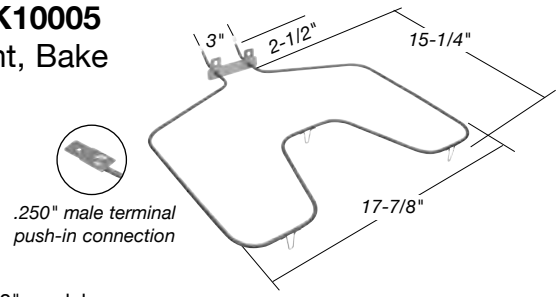

Used on 30" models

CURRENT PRICING CAN BE FOUND ON OUR WEBSITE

All logos, trademarks, part numbers, photos & illustrations are intended solely for identification. Items offered for sale are not represented to be manufactured by the company that built the original equipment.

PHONE: 800-843-0903 • FAX: 800-344-1848 • WEB: [www.pdqsupplyinc.com](http://www.pdqsupplyinc.com) • FB: [facebook.com/pdqsupplyinc](https://facebook.com/pdqsupplyinc)

**WB44K10019**

**Element, Bake**

2000 watts  
240 volts



.250" male terminal  
push-in connection

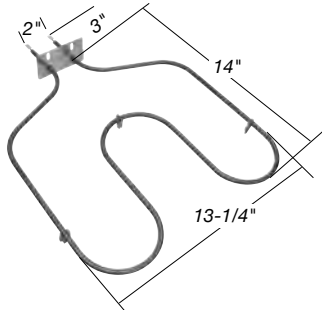

**WB44K5012**

**Element, Bake**

2850/2130 watts  
240/208 volts



.250" male terminal  
push-in connection

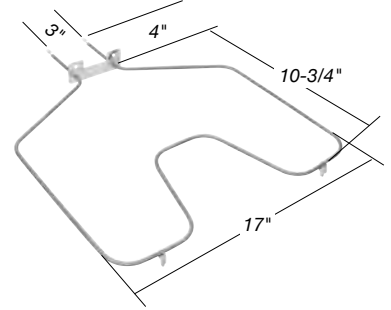

Used on 30" models

**WB44T10010**

**Element, Bake**

2585 watts  
240 volts



.250" male terminal  
push-in connection

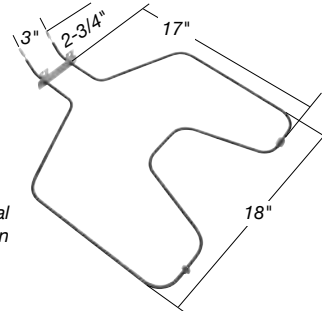

**WB44X173**

**Element, Broil**

3000 watts  
250 volts



screw-in connection

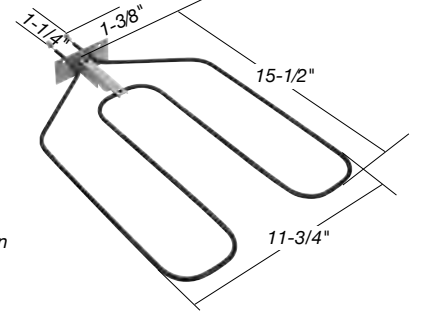

**WB44X190**

**Element, Bake**

3000/2250 watts  
240/208 volts



screw-in connection

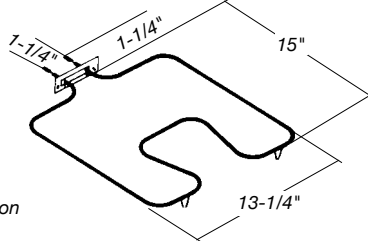

**WB44X232**

**Element, Broil**

2585 watts  
240 volts



.250" male terminal  
push-in connection

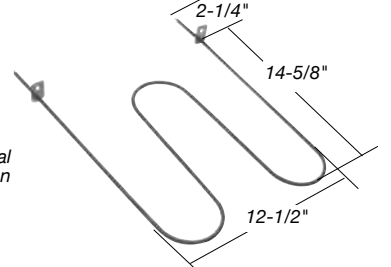

Uses support #WB2X9719

**WB44X5082**

**Element, Bake**

2585/1940 watts  
250/208 volts



screw-in connection

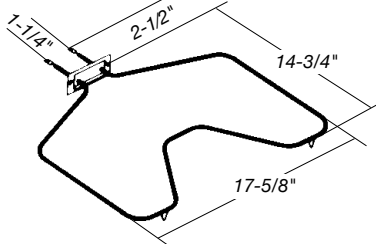

**WB44X5094**

**Element, Bake**

2000/1500 watts  
240/208 volts



.250" male terminal  
push-in connection

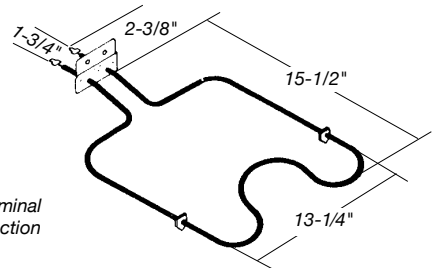

**WB44X5093**

**Element, Broil**

2500 watts  
240 volts



.250" male terminal  
push-in connection

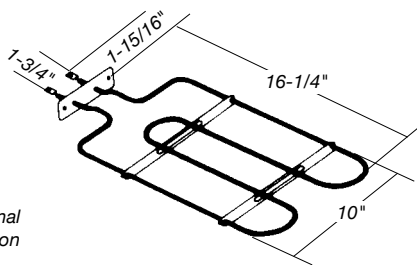

**WB44X5099**

**Element, Bake**

2585/1940 watts  
250/208 volts



screw-in connection

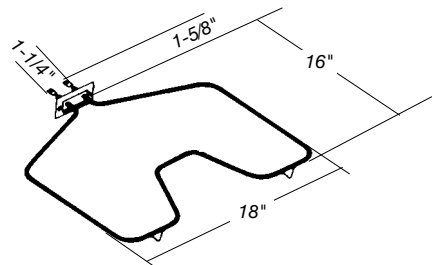

MORE

CURRENT PRICING CAN BE FOUND ON OUR WEBSITE

All logos, trademarks, part numbers, photos & illustrations are intended solely for identification. Items offered for sale are not represented to be manufactured by the company that built the original equipment.

PHONE: 800-843-0903 • FAX: 800-344-1848 • WEB: [www.pdqsupplyinc.com](http://www.pdqsupplyinc.com) • FB: [facebook.com/pdqsupplyinc](https://facebook.com/pdqsupplyinc)

### WB44X10009

**Element, Bake**  
2585/1940 watts  
240/208 volts

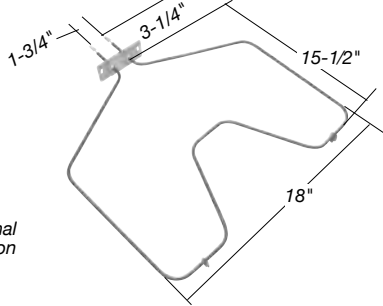

 .250" male terminal  
push-in connection

### WB44X10015

**Element, Broil**  
3410/2565 watts  
240/208 volts

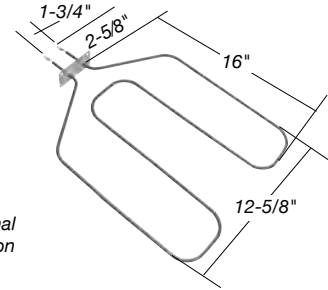

 .250" male terminal  
push-in connection

### WB44X10027

**Element, Broil**  
2300 watts  
240 volts

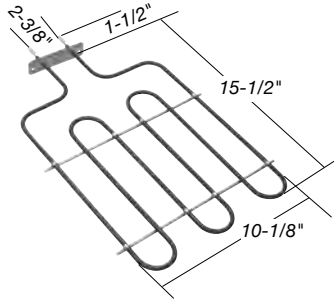

 .250" male terminal  
push-in connection

### WB44X10028

**Element, Bake**  
2000 watts  
240 volts

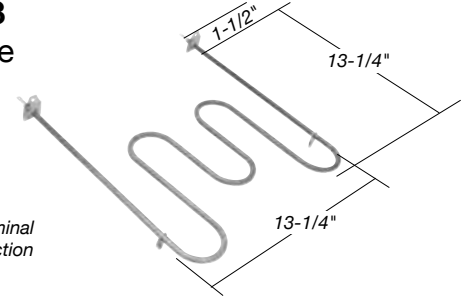

 .250" male terminal  
push-in connection

### WB30K10002

**Element, Surface**  
940W@208V • 1250W@240V  
6" - 3 turns



Plug in type

### WB30K10003

**Element, Surface**  
1580W@208V • 2100W@240V  
8" - 4 turns



### WB30M1

**Element, Surface**  
1000W@208V • 1325W@240V  
6" - 5 turns



Plug in type

### WB30M2

**Element, Surface**  
1765W@208V • 2350W@240V  
8" - 6 turns

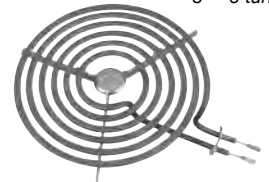

### WB30X254

**Element, Surface**  
940W@208V • 1250W@240V  
6" - 3 turns



Plug in type

### WB30X253

**Element, Surface**  
1580W@208V • 2100W@240V  
8" - 4 turns



### WB30X342

**Element, Surface**  
1000W@208V • 1325W@240V  
6" - 5 turns

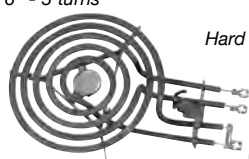

Hard wire type

Includes block

### WB30X341

**Element, Surface**  
1600W@208V • 2125W@240V  
8" - 6 turns

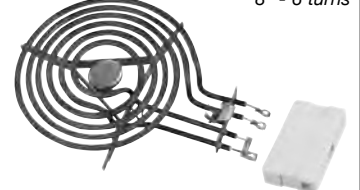

### WB30X356

**Element, Surface**  
1000W@208V • 1325W@240V  
6" - 5 turns



Hard wire type

Includes block

### WB30X354

**Element, Surface**  
1600W@208V • 2125W@240V  
8" - 6 turns



### WB30X359

**Element, Surface**  
1000W@208V • 1325W@240V  
6" - 5 turns



Hard wire type

Includes block

### WB30X348

**Element, Surface**  
1765W@208V • 2350W@240V  
8" - 6 turns



CURRENT PRICING CAN BE FOUND ON OUR WEBSITE

All logos, trademarks, part numbers, photos & illustrations are intended solely for identification. Items offered for sale are not represented to be manufactured by the company that built the original equipment.

PHONE: 800-843-0903 • FAX: 800-344-1848 • WEB: [www.pdqsupplyinc.com](http://www.pdqsupplyinc.com) • FB: [facebook.com/pdqsupplyinc](https://facebook.com/pdqsupplyinc)

**WB30T10078**  
Element, Surface  
1130W@208V • 1500W@240V  
8" - 4 turns



Plug in type

**WB30T10074**  
Element, Surface  
1950W@208V • 2600W@240V  
8" - 5 turns



**WB30T10044**  
10", 2500W, 240V  
**WB30T10047**  
7", 500W, 240V  
Element,  
Radiant Heating

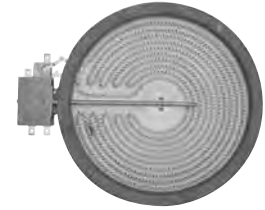

For glass cooktops and freestanding ranges

**NEW**

**WB30T10132**  
**WB30T10045**  
Element,  
Radiant Heating  
8-1/2", 2000W, 240V

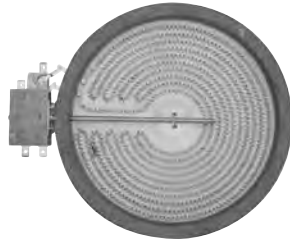

**NEW**

For glass cooktops and freestanding ranges

**WB3T10207**  
Knob, Infinite  
2" dia.

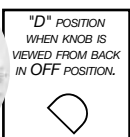
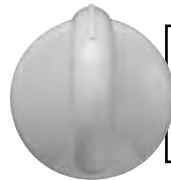

**WB3K10154**  
Knob, Thermostat  
7 o'clock flat "D" position  
Approx. 340° at 6 o'clock  
2-1/2" dia.

**WB3K10201**  
Knob, Infinite  
2" dia

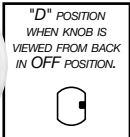

**WB3K10202**  
Knob, Thermostat  
10 o'clock flat "D" position  
Approx. 340° at 6 o'clock  
2-1/2" dia

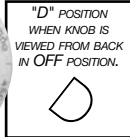

**WB3T10076**  
Knob, Infinite  
2" dia

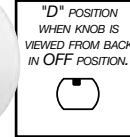

**WB3X10029**  
Knob, Thermostat  
Approx. 340° at 6 o'clock  
2-7/8" dia

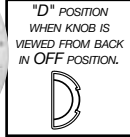

**WB3K10084**  
Knob, Infinite



**WB3K10088**  
Knob, Thermostat

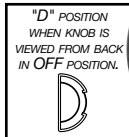
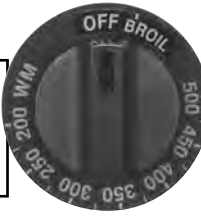

**WB3K5240**  
Knob, Infinite



**WB3K5291**  
Knob, Thermostat

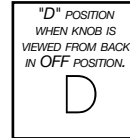
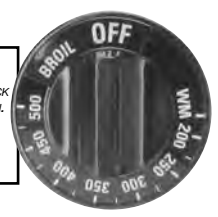

**WB3X10276**  
Knob, Infinite

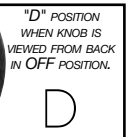

**WB3X10277**  
Knob, Thermostat

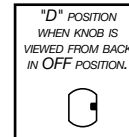

**WB3M26**  
Knob, Infinite



**WB3X5746**  
Knob, Thermostat

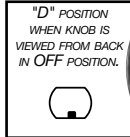

Used on 20" ranges

**MORE**

CURRENT PRICING CAN BE FOUND ON OUR WEBSITE

All logos, trademarks, part numbers, photos & illustrations are intended solely for identification. Items offered for sale are not represented to be manufactured by the company that built the original equipment.

PHONE: 800-843-0903 • FAX: 800-344-1848 • WEB: [www.pdqsupplyinc.com](http://www.pdqsupplyinc.com) • FB: [facebook.com/pdqsupplyinc](https://facebook.com/pdqsupplyinc)



ELECTRIC RANGE PARTS

**WB3X5792**  
Knob, Infinite

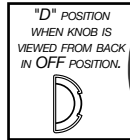
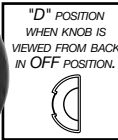

**WB3X5793**  
Knob, Thermostat

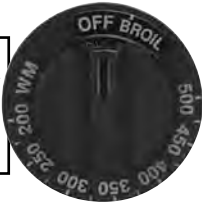

**WB3X5859**  
Knob, Infinite

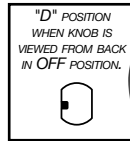

**WB3X5858**  
Knob, Thermostat



**WB3K5069**  
Knob, Infinite

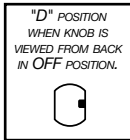

**WB3K5308**  
Knob, Infinite

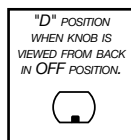

**WB3X464**  
Knob, Infinite

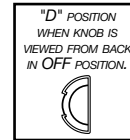

**WB3X439**  
Knob, Infinite



Spring clip

**WB3X378**  
Knob, Selector

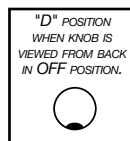

**WB3X376**  
Knob, Thermostat

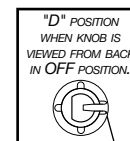

Spring clip

**WB3X10030**  
Knob, Infinite  
2" dia



**WB3T10072**  
Knob, Infinite  
2" dia

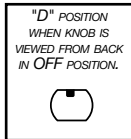

**WB3K10185**  
Knob, Thermostat  
2-7/8" dia

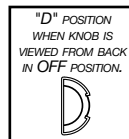

**WB25T10040**  
Light, Indicator  
1/3 watt • 250V



Has (2) .187" male terminals

**WB49X10172**  
Light, Indicator Kit

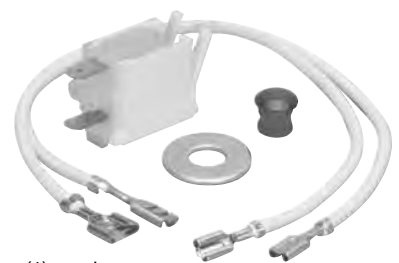

Kit includes:  
(1) indicator light, (1) red lens, (1) washer,  
(2) 9" lead wires w/ .250" and .187" female terminals

CURRENT PRICING CAN BE FOUND ON OUR WEBSITE

All logos, trademarks, part numbers, photos & illustrations are intended solely for identification. Items offered for sale are not represented to be manufactured by the company that built the original equipment.

PHONE: 800-843-0903 • FAX: 800-344-1848 • WEB: [www.pdqsupplyinc.com](http://www.pdqsupplyinc.com) • FB: [facebook.com/pdqsupplyinc](https://facebook.com/pdqsupplyinc)



**WB2X7966**  
Light, Indicator  
*Red lens included*



Has 12" lead wires with (2) .250" male - female piggy back terminals

**WB2X1608**  
Light, Indicator

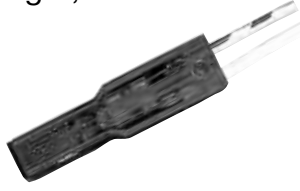

Has 8" lead wires w/ stripped ends

**WB31X5013** 6"  
**WB31X5014** 8"  
Ring, Trim



**WB32X10012** 6"  
**WB32X10013** 8"  
Pan, Drip



**WB31K5024**  
Pan, Drip 6"



**WB31K5025**  
8" Pan, Drip



*Raised Notch*  
*Has small holes*

**WB31M16**  
Pan, Drip 6"



**WB31M15**  
8" Pan, Drip



*Raised Notch*  
*Has small holes*

**WB31T10010**  
Pan, Drip 6"



**WB31T10011**  
8" Pan, Drip



*Raised Notch*  
*Has small holes*

**WB32X107**  
Pan, Drip 6"



**WB32X106**  
8" Pan, Drip



*Has Slot*  
*Has small holes*

**WB31X5010**  
Pan, Drip 6"



**WB31X5011**  
8" Pan, Drip



*No Raised Notch*  
*Has small holes*

**WB32X5075**  
Pan, Drip 6"



**WB32X5076**  
8" Pan, Drip



*Raised Notch*  
*Has small holes*

Used with surface element #WB30M1 & #WB30M2

**WB32K5041**  
Pan, Drip 6"



**WB32K5042**  
8" Pan, Drip



*Has Slot*  
*Has small holes (black porcelain)*

**WB31M20**  
Pan, Drip 6"



**WB31M19**  
8" Pan, Drip



*Raised Notch*  
*Has small holes (black porcelain)*

CURRENT PRICING CAN BE FOUND ON OUR WEBSITE

All logos, trademarks, part numbers, photos & illustrations are intended solely for identification. Items offered for sale are not represented to be manufactured by the company that built the original equipment.

PHONE: 800-843-0903 • FAX: 800-344-1848 • WEB: [www.pdqsupplyinc.com](http://www.pdqsupplyinc.com) • FB: [facebook.com/pdqsupplyinc](https://facebook.com/pdqsupplyinc)

ELECTRIC RANGE PARTS

**WB21X10091**  
**Switch, Infinite**  
 (factory i.d. #50.57079.055)  
 13 amp, 240V  
 Push-to-Turn style



*Spring clip on shaft*

**Voltage sensing type**  
 Used on 20"-24" models  
 Used w/ infinite knob #WB3K10084

**WB21X5243**  
**Switch, Infinite Kit**  
 (replaces factory i.d. #INF240PX1190)  
 (factory i.d. #INF240PX1002)  
 6" or 8", 13 amp, 240V  
 Push-to-Turn style  
 New UL double line break specifications

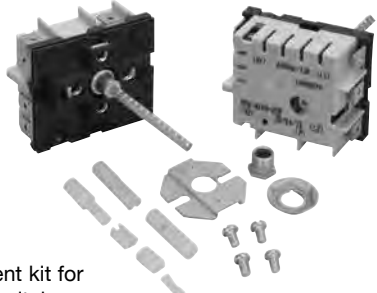

**Voltage sensing type**  
 New Invensys/Robertshaw replacement kit for various voltage sensing type infinite switches.

**WB23K5027**  
**Switch, Infinite**  
 (factory i.d. #NL812641)  
 Used with 8" elements  
 8.9-11 amp, 240V  
 2350W



*Spring clip on shaft*

**Current sensing type**

**WB21X5348**  
 (replaces factory i.d. #NL831473)  
 (factory i.d. #QE214339)  
 Used with 6" elements  
 5.2-6.25 amp, 240V  
 1250-1500W

**WB21X5349**  
 (replaces factory i.d. #NL832458)  
 (factory i.d. #QE214340)  
 Used with 8" elements  
 8.8-10.8 amp, 240V  
 2100-2600W

**Switch, Infinite**



**Current sensing type**

**WB23K10002**  
 (factory i.d. #NL811531)  
 (fact. i.d. #191D3980P001)  
 Used with 6" elements  
 5.4-7.0 amp, 240V

**WB23K10003**  
 (factory i.d. #NL812657)  
 (fact. i.d. #191D3980P002)  
 Used with 8" elements  
 8.9-11.0 amp, 240V

**Switch, Infinite**



**Current sensing type**

**WB23M24**  
 (factory i.d. #KS811520)  
 (factory i.d. #NL811444)  
 (factory i.d. #CTL031)  
 Used with 6" elements  
 5.2-6.6 • 5.4-7.0 amp  
 1500W

**WB23M23**  
 (factory i.d. #KS811009)  
 (factory i.d. #KS812009)  
 (factory i.d. #NL812637)  
 (factory i.d. #CTL030)  
 Used with 8" elements  
 8.9-11.0 • 7.2-9.0 amp  
 2000W

**Switch, Infinite**



*Spring clip on shaft*

**Current sensing type**

**WB24T10022**  
 (factory i.d. #NL811214)  
 Used with 6" elements  
 4.4-5.8 amp, 240V

**WB24T10027**  
 (factory i.d. #NL812118)  
 Used with 8" elements  
 7.5-9.3 amp, 240V

**Switch, Infinite**



*Spring clip on shaft*

**Current sensing type**

**WB24T10029**  
 (fact. i.d. #NL811600)  
 (fact. i.d. #164D1816P08)  
 Used with 6" elements  
 4.4-7.4 amp, 240V

**WB24T10025**  
 (fact. i.d. #NL812653)  
 (fact. i.d. #164D1816P12)  
 Used with 8" elements  
 8.9-11.0 amp, 240V

**Switch, Infinite**



*Spring clip on shaft*

**Current sensing type**

**WB21X10090**  
**Switch, Oven Selector**  
 (factory id # 42.02400.007)



Has (9) .250" male terminals

**WB22X5134**  
**Switch, Oven Selector Kit**  
 (factory i.d. #ASR4167-261)  
 1-13/16" break-off shaft



(7) .250" male terminals

**CURRENT PRICING CAN BE FOUND ON OUR WEBSITE**

All logos, trademarks, part numbers, photos & illustrations are intended solely for identification. Items offered for sale are not represented to be manufactured by the company that built the original equipment.

PHONE: 800-843-0903 • FAX: 800-344-1848 • WEB: [www.pdqsupplyinc.com](http://www.pdqsupplyinc.com) • FB: [facebook.com/pdqsupplyinc](https://facebook.com/pdqsupplyinc)

**WB21X10092**

Thermostat, Oven  
 (factory i.d. #55.17062.160)  
 16 amps, 400 VAC



2 terminals  
 Used on 20"-24" models  
 Used with knob #WB3K10088

**WB24X10149**

Thermostat, Oven  
 (factory i.d. #275-3493-00)  
 22 amp, 125/250V

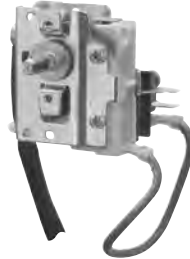

7 terminals

**WB20K10026**

Thermostat, Oven  
 (factory i.d. #223C4029P001)  
 20 amp, 240V



6 terminals  
 Replaces #WB20K10011

**WB20K10019**

Thermostat, Oven  
 (factory i.d. #EA5FT-499-28)  
 (factory i.d. #183D9716P001)  
 30 amps, 240 VAC



Has (6) .250" male terminals

**WB20K10004**

Thermostat, Oven  
 (factory i.d. #EA5F-488-28)  
 (factory i.d. #183D6382P001)  
 30 amps, 240 VAC



Has (6) .250" male terminals

**WB20X5071**

Thermostat, Oven  
 (factory i.d. #EA5F-479-28)  
 (factory i.d. #164D3084P001)  
 30 amps, 240 VAC



Has (6) .250" male terminals

**WB20K5027**

Thermostat, Oven  
 (factory i.d. #275-3200-00)  
 (factory i.d. #275-3140-13)  
 25 amps, 125/250 VAC



5 terminals

**WB20K5031**

Thermostat, Oven  
 (factory i.d. #275-3209-00)  
 (factory i.d. #275-3140-15)  
 20 amps, 120/240 VAC



5 terminals

**WB24X5252**

(factory i.d. #6713G0018)  
 17 amp, double pole, variable broil, 6 terminals

**WB24X5358**

(factory i.d. #6703G0007)  
 17 amp, single pole, variable broil, 4 terminals

**WB24X5285**

(factory i.d. #6707G0011)  
 17 amp, single pole, fixed broil, 4 terminals

Thermostat, Oven  
 120-240 VAC



**WB21X5287**

Thermostat, Oven  
 (factory i.d. #275-3180-00)  
 (factory i.d. #164D2640P002)  
 25 amps, 125/250 VAC



5 terminals

**WB21X489**

Thermostat, Oven  
 (factory i.d. #6707G0008)  
 17 amp bake 15 amp fixed broil  
 120-240 VAC



4 terminals

CURRENT PRICING CAN BE FOUND ON OUR WEBSITE

All logos, trademarks, part numbers, photos & illustrations are intended solely for identification. Items offered for sale are not represented to be manufactured by the company that built the original equipment.

PHONE: 800-843-0903 • FAX: 800-344-1848 • WEB: [www.pdqsupplyinc.com](http://www.pdqsupplyinc.com) • FB: [facebook.com/pdqsupplyinc](https://facebook.com/pdqsupplyinc)

MISC. RANGE PARTS

**40A15**

Bulb, Appliance

40 Watt, 130 Volt



**WB2X5041D**

Clip, Diastat



12 pack

**WB7K11** Right

**WB7K12** Left

Endcap, Backguard

8-7/16" overall height  
Black finish

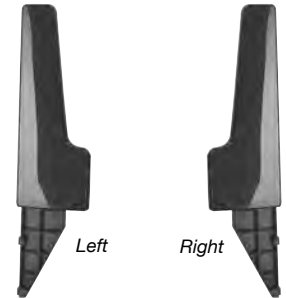

**WB7K380** Right

**WB7K381** Left

Endcap, Backguard

14-1/8" overall height  
Black finish



**WB7X7330** Left

**WB7X7331** Right

Endcap, Backguard

Black finish



Uses rivet #**WB1X5790**

**WB7K186** Right

**WB7K187** Left

Endcap,  
Oven Handle

Chrome finish

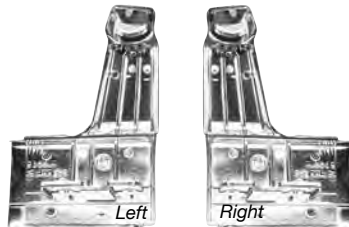

Used with oven handle #**WB15X5174**

**WB7X10034**

Endcap, Door Handle

Black finish



Used with handle #**WB15X10003**

**WB2X8391** 8-3/4" x 10-1/2" x 3/32"

**WB6X486** 9" x 7-3/4" x 3/32"

Filter, Grease



**NEW**

**WB2X10700**

Filter, Microwave/Hood

10-1/2" x 8-15/16" x 3/32"



**NEW**

**WB2X5103**

44-1/2" overall length (A)

**WB2X2058**

43-1/2" overall length (B)

**WB2X1522**

64-1/2" overall length (B)

Gasket, Oven Door  
Formed U-Shaped

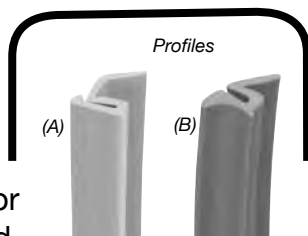

**WB4K10019**

40" overall length

Used on 20" ranges

Has 10 stationary mounting clips

**WB32K3**

54" overall length

Used on 30" ranges

Has 16 stationary mounting clips

Gasket, Oven Door  
Formed U-Shaped



CURRENT PRICING CAN BE FOUND ON OUR WEBSITE

All logos, trademarks, part numbers, photos & illustrations are intended solely for identification. Items offered for sale are not represented to be manufactured by the company that built the original equipment.

PHONE: 800-843-0903 • FAX: 800-344-1848 • WEB: [www.pdqsupplyinc.com](http://www.pdqsupplyinc.com) • FB: [facebook.com/pdqsupplyinc](https://facebook.com/pdqsupplyinc)

**WB32K5051**

Gasket, Oven Door  
Formed U-Shaped  
50" overall length



**WB2X10887**

Gasket, Oven Door  
Formed One Piece  
Approx. 18" wide x 14" high



Has (4) fixed clips  
located one at each corner

**WB2X7891**

13-3/8" overall length, door side

**WB2X7892**

14-5/8" overall length, door top

Gasket, Oven Door  
"Stretch Seals"



Used on 20" gas & electric ovens

**WB4K1**

Gasket, Oven Door  
74" overall length



Hollow fiberglass rope gasket  
Used on self cleaning ovens

**WB15X10003**

Handle, Oven Door  
21" overall length  
Black finish



Uses handle endcap #WB7X10034

**WB15X5174**

Handle, Oven Door  
27-1/2" overall length  
Black finish



Uses handle endcaps  
#WB7K186 & #WB7K187

**WB15K1**

Handle, Oven/Broiler Door  
29" overall length  
18" & 22-7/8" on center holes  
Chrome finish



**WB9K2** Right

**WB9K3** Left

Spring,  
Broiler Door

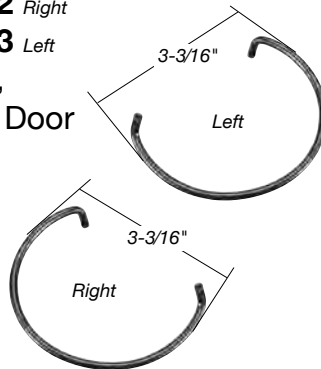

**WB10K12**

Hinge, Oven Door



**WB14X104** Right (shown)

**WB14X103** Left

Hinge, Oven Door



**WB10X236**

Hinge, Oven Door



Includes spring.

CURRENT PRICING CAN BE FOUND ON OUR WEBSITE

All logos, trademarks, part numbers, photos & illustrations are intended solely for identification. Items offered for sale are not represented to be manufactured by the company that built the original equipment.

PHONE: 800-843-0903 • FAX: 800-344-1848 • WEB: [www.pdqsupplyinc.com](http://www.pdqsupplyinc.com) • FB: [facebook.com/pdqsupplyinc](https://facebook.com/pdqsupplyinc)



MISC. RANGE PARTS

**WB2K10254**

Kit, Anti-Tip  
7-3/8" x 3-3/4"



**WB2X7909**

Kit, Anti-Tip  
51-1/2" length

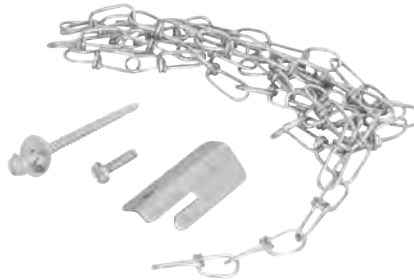

**WB3X5699**

Knob, Clock  
7/8" tall



**WB48K10015**

Pan, Broiler  
8-3/8" W x 13-1/2" D

Pan & grid are sold separately

**WB48K10016**

Grid, Broiler  
8-5/8" W x 12-3/4" D



**WB49K2**

Pan, Broiler  
17" W x 16-1/8" D

Pan & grid are sold separately

**WB48K2**

Grid, Broiler  
17" W x 15-5/8" D



**WB49X5380**

Pan, Broiler  
12-1/2" W x 16-3/8" D

Pan & grid are sold separately

**WB48X5093**

Grid, Broiler  
12-7/8" W x 15-1/4" D  
(porcelain)



**WB48X10056**

Pan & Grid, Combo Broiler

Pan: 12-1/2" W x 17" D  
Grid: 12-5/8" W x 15-5/16" D



**WB48K5019**

**WB48T10095** NEW

Rack, Oven  
23-3/4" W x 17-1/2" D

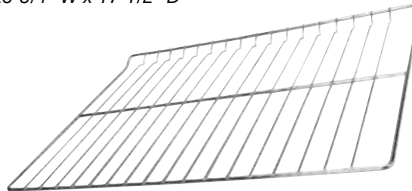

Used on 30" ranges

**WB48M4**

Rack, Oven  
22-3/8" W x 16-1/4" D

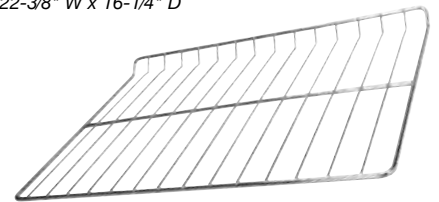

Used on 30" ranges

**WB48X5094**

Rack, Oven  
15-3/4" W x 15-3/4" D

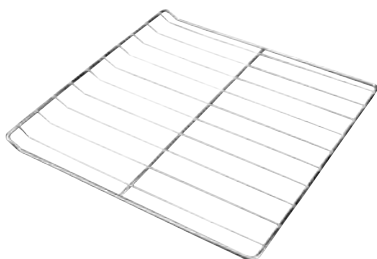

Used on 20" ranges

**WB48X5099**

Rack, Oven  
22-7/8" W x 16" D

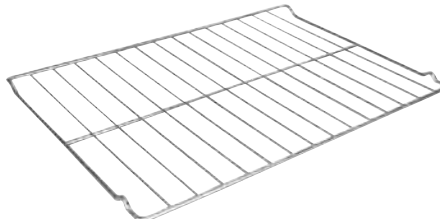

Used on 30" models

**WB6K8**

Support, Main Top  
11-1/2" x 4-1/8"



CURRENT PRICING CAN BE FOUND ON OUR WEBSITE

All logos, trademarks, part numbers, photos & illustrations are intended solely for identification. Items offered for sale are not represented to be manufactured by the company that built the original equipment.

PHONE: 800-843-0903 • FAX: 800-344-1848 • WEB: [www.pdqsupplyinc.com](http://www.pdqsupplyinc.com) • FB: [facebook.com/pdqsupplyinc](https://facebook.com/pdqsupplyinc)

**WB62K10001**  
Top, Main - Gas  
30"



Uses grate #WB31K10012

**WB62X5476**  
Top, Main - Gas  
24"



**WB62X5461**  
Top, Main - Gas  
20"



The endcaps listed on this page reflect some common matches. Please refer to the endcaps shown on the previous pages to identify your endcap. If you are still uncertain as to which endcap you need, please order by model number to insure that you receive the correct endcap for your application.

The factory approved replacement part may differ slightly in appearance, length or color to the original. If necessary, cut to the appropriate length using the original part as a pattern and smooth any rough edges.

**WR17X2296\***  
22-7/8" x 1-3/8"

**WR17X3692\***  
20-9/16" x 1-3/8"

**WR17X3881\***  
20-3/8" x 1-3/8"

**WR17X3942\***  
20-5/8" x 1-3/8"

**WR17X10667**  
20-5/8" x 1-3/8"

**WR17X10685**  
20-3/8" x 1-3/8"

Bar, Door



\*Uses R/L endcap #WR2X9162

**WR17X10846\***  
21-1/4" x 2"

**WR17X10670**  
20-3/4" x 2" Has gray stripe

**WR17X3691**  
20-3/4" x 2"

**WR17X3880\*\***  
21-1/4" x 2"

**WR17X11774\***  
21-3/8" x 2"

**WR71X10077\*\***  
24-1/2" x 2"

**WR71X10080\*\***  
22-5/8" x 2"

**WR71X10081\*\***  
21-15/16" x 2"

Bar, Door



\*Uses R/L endcap #WR2X9144  
\*\*Uses R/L endcap #WR2X9144 & WR2X8345

**WR71X10281**  
21-9/16" x 2-1/4"

**WR71X10282**  
9-3/4" x 2-1/4"

Bar, Door



Fits endcap number:  
WR2X10789 (R), WR2X10790 (L)

**WR71X2194**  
25-7/8" x 2-1/8"

**WR71X2502**  
23" x 2-1/8"

**WR71X10731**  
29-1/8" x 2-1/8"

Bar, Door



Fits R/L endcap #WR2X7975

**WR71X2166**

Bar, Door  
24" x 1-7/16"



Fits R/L endcap #WR2X8221

**WR17X3867**

Bar, Door  
17" x 1-3/8"  
PVC plastic



Fits R/L endcap #WR2X9273

**WR17X11889**

Bar, Door

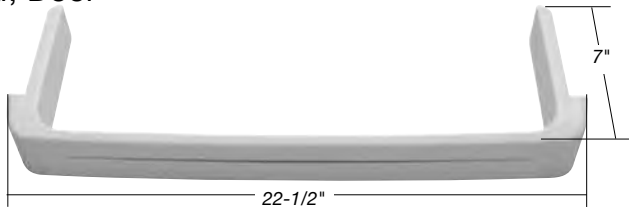

White with blue stripe

**WR17X11890**

Bar, Door

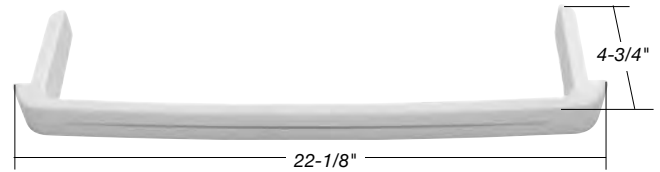

White with blue stripe

**WR60X114**

Blade, Evaporator Fan  
Counter clockwise rotation  
4-1/2" dia., white



**WR60X10204**

Blade, Evaporator Fan  
Counter clockwise rotation  
4-1/2" dia., black



**WR55X10942**

Board, Control  
(factory i.d. #200D4850G002)  
8" x 5"



**WR55X10397**

Board, Adaptive Defrost  
(factory i.d. #197D1240G005)  
4-1/4" x 2-1/2"



**40A15**

Bulb, Appliance  
40 watt, 130 volt



**WR62X79**

(factory i.d. #JSU21X126)  
210VAC • 12µF

**WR62X80**

(factory i.d. #JSU21X156)  
210VAC • 15µF

Capacitor, Run



Has (2) .187" male terminals

CURRENT PRICING CAN BE FOUND ON OUR WEBSITE

All logos, trademarks, part numbers, photos & illustrations are intended solely for identification. Items offered for sale are not represented to be manufactured by the company that built the original equipment.

PHONE: 800-843-0903 • FAX: 800-344-1848 • WEB: [www.pdqsupplyinc.com](http://www.pdqsupplyinc.com) • FB: [facebook.com/pdqsupplyinc](https://facebook.com/pdqsupplyinc)

**WR9X491**

Control, Cold  
 (factory i.d. #3ART5VC131)  
 (factory i.d. #3ART5VC163)  
 19" capillary



**WR9X355**

Control, Cold  
 (factory i.d. #3ART5VC96)  
 18" capillary



**WR9X547**

(factory i.d. #3ART5VC137)  
 (factory i.d. #3ART5VC163)  
 19" capillary

**WR9X10027**

(factory i.d. #3ART5VC146)  
 (factory i.d. #3ART5VC171)  
 15" capillary

Control, Cold



**WR9X10011**

Control, Cold  
 (factory i.d. #3ART5VC144)  
 (factory i.d. #3ART5VC171)  
 15" capillary



**WR9X10042**

Control, Cold  
 (factory i.d. #3ART5VC154)  
 (factory i.d. #197D3479-01)  
 (factory i.d. #3ART5VAA142)  
 15" capillary



**WR9X10074**

Control, Cold  
 (factory i.d. #3ART5C184)  
 (factory i.d. #136C6234-10)  
 15" capillary



**WR9X10155**

Control, Cold  
 (factory i.d. #WPF5T-L)  
 (factory i.d. #WPF5K-178-211)  
 14" capillary

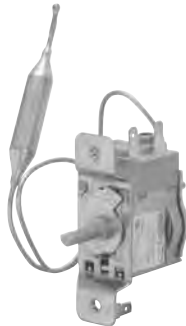

**WR82X10111**

Cover, Access  
 28-3/16" W x 12-1/2" H

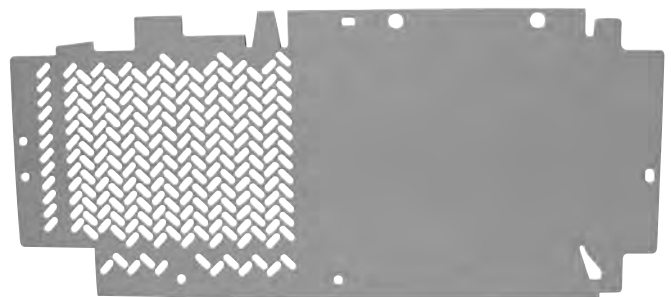

**WR17X10666**

Cover, Air Actuator  
 14-7/8" H x 6-3/4" W



Has (2) mounting tabs on front bottom  
 Uses air actuator knob #WR2X9158

CURRENT PRICING CAN BE FOUND ON OUR WEBSITE

All logos, trademarks, part numbers, photos & illustrations are intended solely for identification. Items offered for sale are not represented to be manufactured by the company that built the original equipment.

PHONE: 800-843-0903 • FAX: 800-344-1848 • WEB: [www.pdqsupplyinc.com](http://www.pdqsupplyinc.com) • FB: [facebook.com/pdqsupplyinc](https://facebook.com/pdqsupplyinc)

## WR32X10457

Crispers  
Cover, Crisper  
24-3/4" W x 18-1/2" D



Used with crisper pan #WR32X10477

## WR32X10398

Crispers  
Cover, Crisper  
24-1/2" W x 18-3/4" D



## WR32X10537

Crispers  
Cover, Pan  
24-3/4" W x 18" D

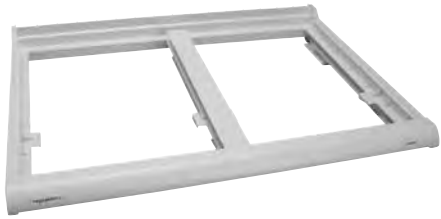

Used with pan #WR32X10181

## WR17X11662

Crispers  
Cover, Vegetable Pan  
24-5/8" W x 18-1/2" D  
White



## WR32X10340

Crispers  
Pan, Vegetable Twin  
11-3/8" W x 14-1/2" deep x 6-1/2" H  
Clear



These parts are not sold as a set.  
please order each part separately.

## WR32X1455

Crispers  
Pan, Crisper  
11-3/8" wide x 14-1/2" deep x 6-1/4" high



Used with crisper cover #WR32X1094

## WR32X1104

Pan, Crisper  
22-1/4" wide x 14-1/2" deep x 6" high

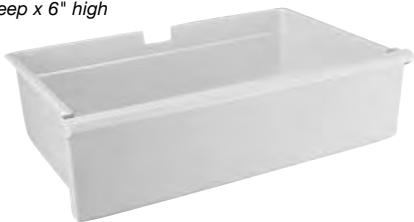

## WR22X487

Door/Cover, Dairy

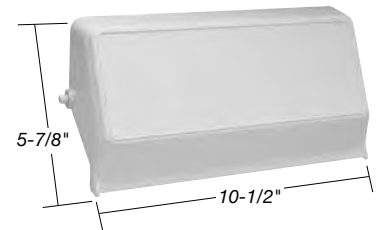

## WR2X20092

Duct, Foam  
Styrofoam

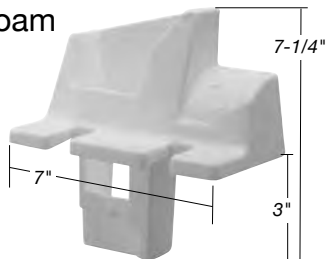

## WR2X8462

Duct, Foam  
Styrofoam

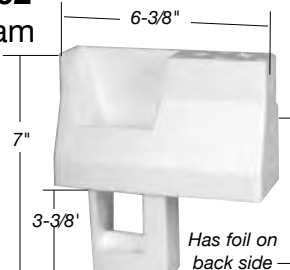

## WR2X10701

Duct, Foam  
Styrofoam

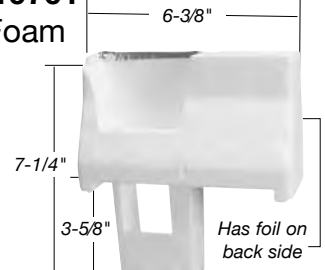

CURRENT PRICING CAN BE FOUND ON OUR WEBSITE

All logos, trademarks, part numbers, photos & illustrations are intended solely for identification. Items offered for sale are not represented to be manufactured by the company that built the original equipment.

PHONE: 800-843-0903 • FAX: 800-344-1848 • WEB: [www.pdqsupplyinc.com](http://www.pdqsupplyinc.com) • FB: [facebook.com/pdqsupplyinc](https://facebook.com/pdqsupplyinc)



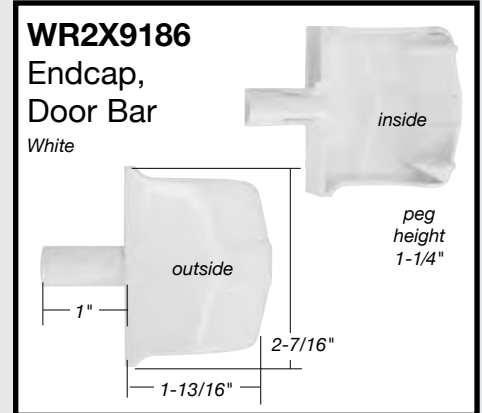
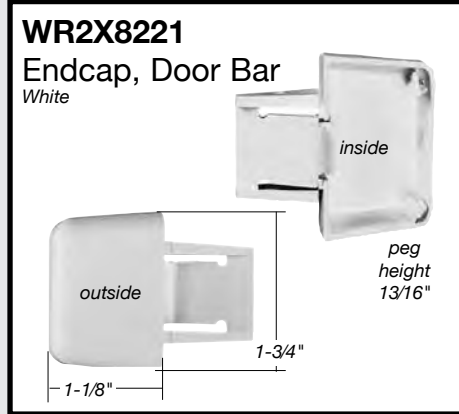
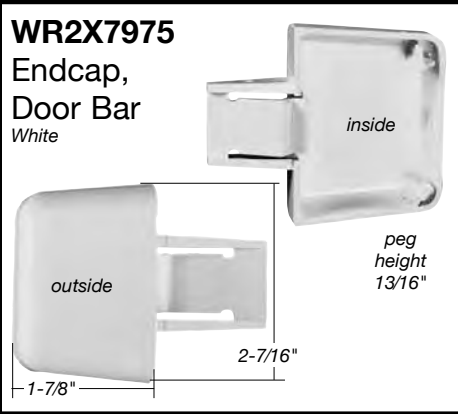
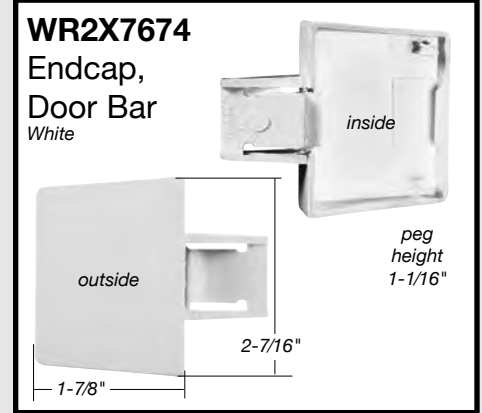
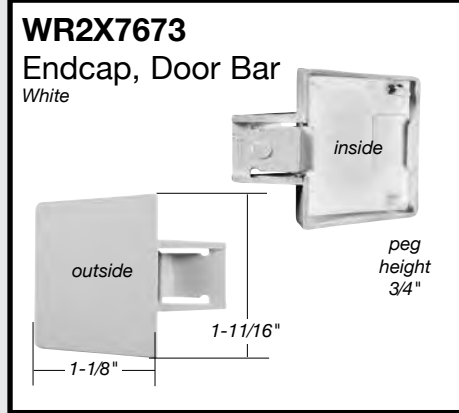
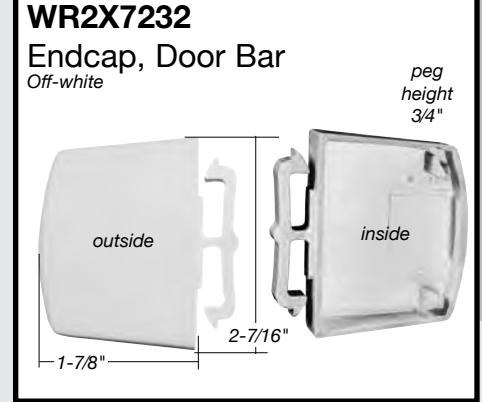
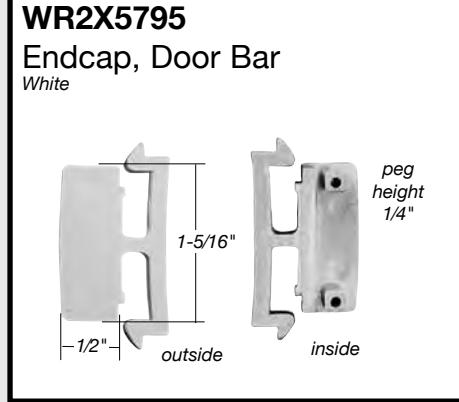

CURRENT PRICING CAN BE FOUND ON OUR WEBSITE

All logos, trademarks, part numbers, photos & illustrations are intended solely for identification. Items offered for sale are not represented to be manufactured by the company that built the original equipment.

PHONE: 800-843-0903 • FAX: 800-344-1848 • WEB: [www.pdqsupplyinc.com](http://www.pdqsupplyinc.com) • FB: [facebook.com/pdqsupplyinc](https://facebook.com/pdqsupplyinc)

REFRIGERATOR PARTS

## WR2X10790

### Endcap, Door Bar

Left hand  
6-3/4" overall length

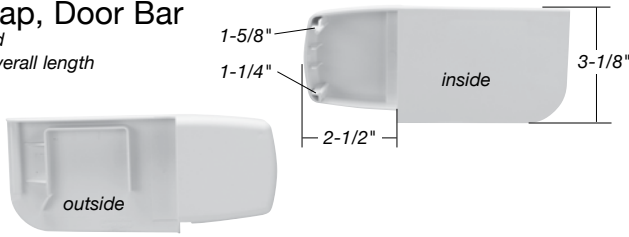

## WR2X10789

### Endcap, Door Bar

Right hand  
6-3/4" overall length

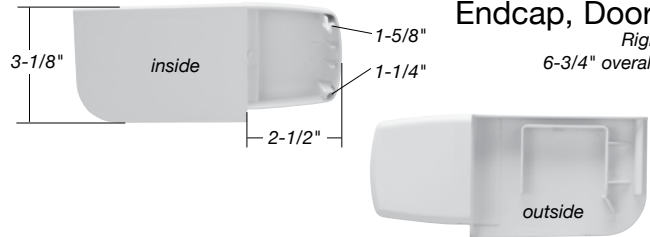

## WR2X10792

### Endcap, Door Bar

Left hand  
6" overall length

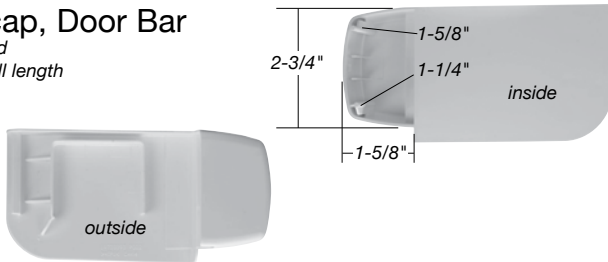

## WR2X10791

### Endcap, Door Bar

Right hand  
6" overall length

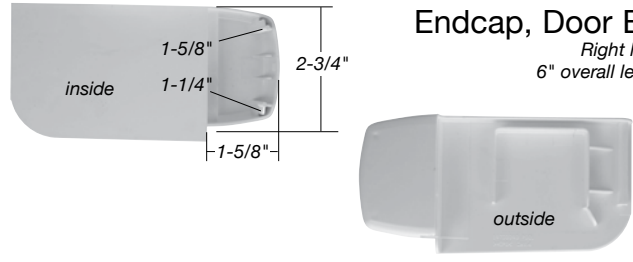

## WR2X11521

### Endcap, Door Bar

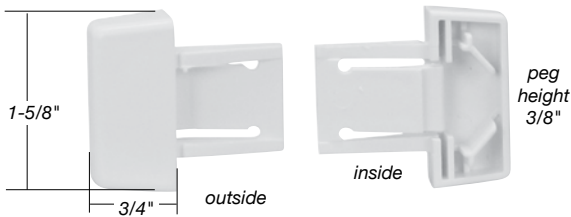

## WR2X7791

### Endcap, Handle

Plastic - chrome finish  
3-1/8" overall length



## MWF

### Filter, Water



Reduces lead, chlorine & particulates  
Improves taste & reduces odor  
Fits all refrigerator models manufactured  
by General Electric and Hotpoint



[www.pdqsupplyinc.com](http://www.pdqsupplyinc.com)

**"LIKE" us on Facebook!**  
Go to our website and click  
the Like button on the right.



CURRENT PRICING CAN BE FOUND ON OUR WEBSITE

All logos, trademarks, part numbers, photos & illustrations are intended solely for identification. Items offered for sale are not represented to be manufactured by the company that built the original equipment.

PHONE: 800-843-0903 • FAX: 800-344-1848 • WEB: [www.pdqsupplyinc.com](http://www.pdqsupplyinc.com) • FB: [facebook.com/pdqsupplyinc](https://www.facebook.com/pdqsupplyinc)

**Gaskets, Door**

Please order gaskets by appliance model number

PROFILE A



PROFILE B



PROFILE C

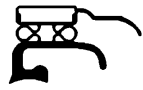

PROFILE D

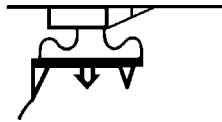

PROFILE E

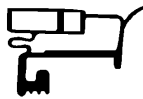

PROFILE F

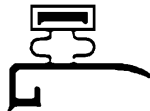

PROFILE G

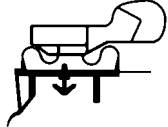

PROFILE H

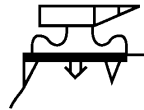

PROFILE I



PROFILE J



Gasket #	Color	Profile	Door Type
<b>WR14X10158</b>	White	–	Food
<b>WR14X10162</b>	White	–	Freezer
<b>WR24X10231</b>	White	H	Food
<b>WR24X10228</b>	White	H	Freezer
<b>WR24X10229</b>	White	H	Food
<b>WR24X10236</b>	White	H	Food
<b>WR24X286</b>	White	E	Freezer
<b>WR24X287</b>	Brown	F	Food
<b>WR24X312</b>	White	C	Freezer
<b>WR24X313</b>	White	F	Food
<b>WR24X318</b>	Brown	F	Food
<b>WR24X319</b>	White	F	Food
<b>WR24X446</b>	White	H	Food
<b>WR24X449</b>	White	H	Freezer
<b>WR24X450</b>	White	D	Food
<b>WR24X481</b>	Brown	H	Food
<b>WR24X524</b>	White	H	Freezer
<b>WR24X527</b>	White	E	Freezer
<b>WR24X528</b>	White	E	Food
<b>WR24X564</b>	White	–	Food
<b>WR24X10136</b>	White	J	Food
<b>WR24X10186</b>	White	I	Food
<b>WR24X10187</b>	White	I	Freezer

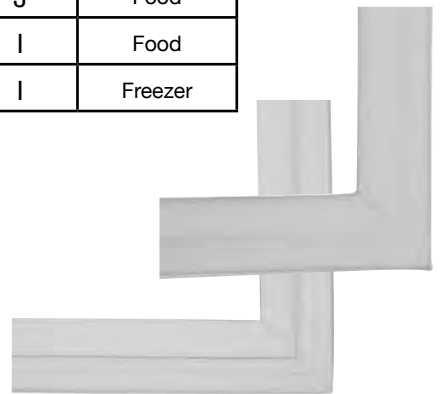

**PLEASE ORDER GASKETS BY APPLIANCE MODEL NUMBER**

*\*The OEM makes frequent gasket substitutions, thus the approved replacement part may be of a different color and at times a slightly different gasket dimension. We always try to keep original gaskets available as much as possible. Should you have any concerns regarding your gasket needs, please order by model number to insure that you receive the correct gasket.*

CURRENT PRICING CAN BE FOUND ON OUR WEBSITE

All logos, trademarks, part numbers, photos & illustrations are intended solely for identification. Items offered for sale are not represented to be manufactured by the company that built the original equipment.

PHONE: 800-843-0903 • FAX: 800-344-1848 • WEB: [www.pdqsupplyinc.com](http://www.pdqsupplyinc.com) • FB: [facebook.com/pdqsupplyinc](https://facebook.com/pdqsupplyinc)

**WR12X10058**

Handle, Food Door  
21-3/8" overall length



**WR12X10107**

Handle, Food Door  
20-1/4" overall length



**WR12X10966**

Handle, Freezer Door  
18-3/4" overall length



**WR12X10108**

Handle, Freezer Door  
18-3/4" overall length



**WR12X933**

Handle Grip, Door  
Plastic - white finish

**WR12X948**

Handle, Insert, Door  
Plastic - white finish



\*Grip and insert are sold separately

**WR51X442**

Heater, Defrost Quartz Tube

Overall: 9-1/2"  
115V • 600W

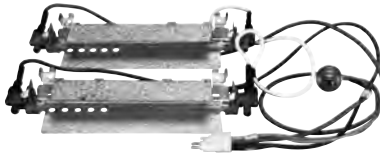

2 tubes  
Includes: defrost thermostat, wiring  
assembly & attached brackets

**WR51X10101**

Heater, Defrost Quartz Tube

Double tube heater  
Overall length: 9-1/2"  
115V • 575W

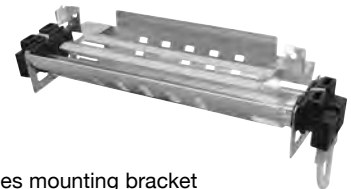

Includes mounting bracket  
This is GE's replacement for the  
single tube heater #WR51X10053

**WR51X10053**

Heater, Defrost Quartz Tube

Single tube heater  
Overall length: 9-1/2"  
115V • 575W

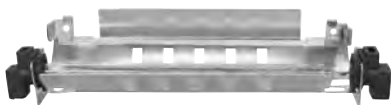

Includes mounting bracket  
This is the GE's single tube style heater  
which is NLA from GE. GE subs to the  
double tube heater #WR51X10101

**WR51X365**

Overall length: 16-1/2"  
115V • 300W

**WR51X10075**

Overall length: 17-1/4"  
115V • 360W

Heater, Defrost  
Quartz Tube



CURRENT PRICING CAN BE FOUND ON OUR WEBSITE

All logos, trademarks, part numbers, photos & illustrations are intended solely for identification. Items offered for sale are not represented to be manufactured by the company that built the original equipment.

PHONE: 800-843-0903 • FAX: 800-344-1848 • WEB: [www.pdqsupplyinc.com](http://www.pdqsupplyinc.com) • FB: [facebook.com/pdqsupplyinc](https://facebook.com/pdqsupplyinc)

**WR49X393**

Heater, Defrost Calrod

20-3/4" overall length  
115V • 425W

Includes: thermal fuse



**WR51X464**

Heater, Defrost Calrod

20" overall length  
115V • 400W

Includes: thermal fuse & mounting bracket



**WR51X444**

Overall length: 22"  
115V • 625W

**WR51X10038**

Overall length: 21-1/8"  
115V • 375W

Heater, Defrost  
Quartz Tube



**WR2X9393**

Heater, Evaporator  
Drain Tube

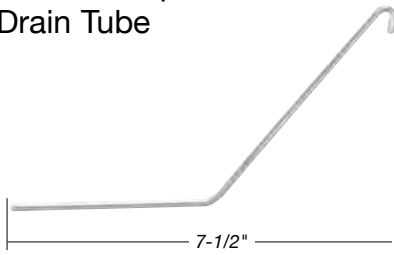

Prevents ice build-up in the drain tube

**WR17X12852**

Housing, Control



**WR2X8231 (A)**

2-1/4" overall length  
1" dia. face  
temp. markings: 1-9, Off

**WR2X13355 (B)**

2-3/4" overall length  
1" dia. face  
temp. markings: Off

Knob,  
Cold Control

You may receive either style depending on what we have in inventory at the time of your order.

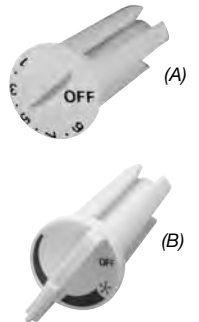

**WR60X187**

Motor, Condenser Fan

(factory i.d. #5KSM51AG3959)  
(factory i.d. #5KSM81FFL0077)  
115V - 1550 rpm

Has (3)  
male pins



Includes washer, push nut & (3) screws  
Used with fan blade #WR60X275

**WR60X10168**

Motor, Condenser Fan

(factory i.d. #23213GEA)  
0.193 amp  
11 watt, 115V  
1-1/4" shaft



10" leads with quick disconnect  
with (3) male pin connections.

**WR60X10350**

Motor, Condenser Fan

(Replaces: factory i.d. #UDQR007G8L)  
(factory i.d. #197D2411P010)  
(factory i.d. #197D2411P014)  
4.7 watt, 115V  
1-3/4" shaft



6" lead wires with quick disconnect with (2) male pin connections  
Used with condenser fan blade #WR60X10206

**NEW**

CURRENT PRICING CAN BE FOUND ON OUR WEBSITE

All logos, trademarks, part numbers, photos & illustrations are intended solely for identification. Items offered for sale are not represented to be manufactured by the company that built the original equipment.

PHONE: 800-843-0903 • FAX: 800-344-1848 • WEB: www.pdqsupplyinc.com • FB: facebook.com/pdqsupplyinc



### WR60X162

#### Motor, Evaporator Fan

(factory i.d. #5KSB44QSE176B)

.135 amp

3000 rpm

1-3/8" shaft

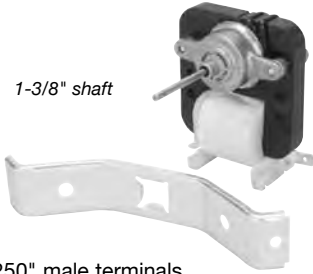

Has (3) .250" male terminals

### WR60X190

#### Motor, Evaporator Fan

(factory i.d. #5KSB44QS1380B)

3000 rpm

1-1/8" shaft



Has (2) .250" male terminals and (1) .187" male terminal

### WR60X191

#### Motor, Evaporator Fan

(factory i.d. #5KSB44QSE232B)

3000 rpm

1" shaft



Has (1) .187" male terminal  
Lead wires have (2) .250" male terminals

### WR60X203

#### Motor, Evaporator Fan

(factory i.d. #5KSB44QS1431A)

(factory i.d. #5KSB44QSE232B)

(Used with fan blade #WR60X114)

3000 rpm

1-3/16" shaft



Has (2) .250" male terminals  
and (1) .187" male terminal

### WR60X253

#### Motor, Evaporator Fan

(factory i.d. #5SME44AG1013)

2600 rpm

1-1/16" shaft



.12 amp • 3.4W

### WR60X10141

#### Motor, Evaporator Fan

(factory i.d. #197D2038P011)

115V, 3.0 watt

1-3/8" shaft



3-3/4" lead wires w/ quick disconnect that  
has (2) male pin connections

### WR60X10172

#### Motor, Evaporator Fan

(factory i.d. #IS-23210)

2800 rpm

2-1/4" shaft



4" lead wires w/ quick disconnect  
that has (3) male pin connections

### WR60X10185

#### Motor, Evaporator Fan

(factory i.d. #197D2039P013)

9.75V DC, 3.25 watt

2-1/4" shaft



12" lead wires w/ quick disconnect that  
has (4) male pin connections

### WR60X10240

#### Motor, Evaporator Fan

(factory i.d. #197D2038P013)

115V, 3.0 watt

2-3/16" shaft



5" lead wires w/ quick disconnect that has  
(3) female pin connectors

### WR60X10257

#### Motor, Evaporator Fan

(factory i.d. #200D7178P001)

115V, 2.3 watts

2-3/16" shaft



13" lead wires w/ quick disconnect that has  
(2) male pin connectors

### WR60X10285

#### Motor, Evaporator Fan

(factory i.d. #197D3957P012)

.11 amp, 6.7 watts

2650 rpm

1-7/16" shaft



3" leads w/ quick  
disconnect that has  
(2) male pin connections

### WR60X10300

(replacement for: factory

i.d. #UDQR002C3RL

(factory i.d. #187D1931G002)

1-3/4" shaft

115V • 4.2 watts

### WR60X10126

(factory id #UDQR002C3RLS)

1-5/8" shaft

115V • 4.2 watts

#### Motor, Evaporator Fan

14" lead wires w/ quick disconnect that has  
(2) female pin connections

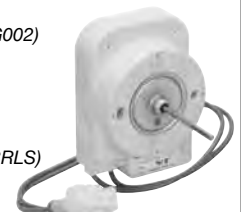

CURRENT PRICING CAN BE FOUND ON OUR WEBSITE

All logos, trademarks, part numbers, photos & illustrations are intended solely for identification. Items offered for sale are not represented to be manufactured by the company that built the original equipment.

PHONE: 800-843-0903 • FAX: 800-344-1848 • WEB: [www.pdqsupplyinc.com](http://www.pdqsupplyinc.com) • FB: [facebook.com/pdqsupplyinc](https://www.facebook.com/pdqsupplyinc)

**WR8X167**

(factory i.d. #314MFBYY-53)

**WR8X122**

(factory i.d. #414RFBYY-53)

**Overload**



Has (1) .250" male terminal

**WR7X10131**

**Overload/Relay, Combination**

(factory i.d. #197D4848P004)  
(factory i.d. #197D8031P001)  
(overload factory i.d. #319MFBYY-53)



Has (2) .250" male terminals  
and (2) .250" female terminals

**WR9X10105**

(overload i.d. #314LFBYY-53)

**WR9X10106**

(overload i.d. #283ULBYY-53)

**Overload/Relay, Combination**



Has (2) .250" male terminal  
and (2) .187" female terminals

**WR9X10107**

**Overload/Relay, Combination**

(overload i.d. #189RHBYY-53)



Has (2) .250" male terminal  
and (2) .187" female terminals

**WR7X10011**

**Relay, Start**



Has (2) .250" male terminals

**WR7X10051**

**Relay, Start**



Has (3) .250" male terminals

**WR71X2451**

**Shelf, Ice Tray**

11-1/2" W x 12-3/8" D



**WR71X10378**

**Shelf, Wire**

24-1/2" W x 14-3/8" D

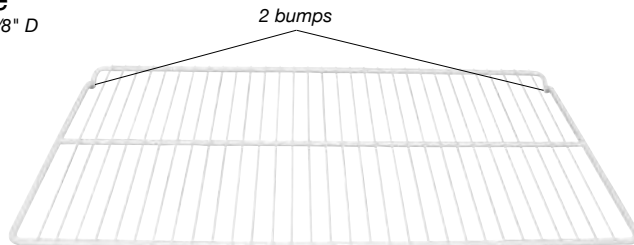

**WR2X9391**

**Socket, Light**



Has (2) .250" male terminals

**WR23X10143**

**Switch, Light**

5 amp - 125V  
2.5 amp - 250V



Has (2) .187" male terminals

**WR2X6817**

**Support**

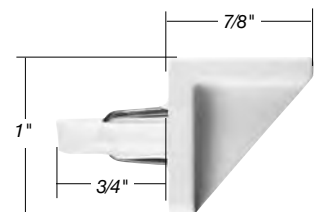

CURRENT PRICING CAN BE FOUND ON OUR WEBSITE

All logos, trademarks, part numbers, photos & illustrations are intended solely for identification. Items offered for sale are not represented to be manufactured by the company that built the original equipment.

PHONE: 800-843-0903 • FAX: 800-344-1848 • WEB: [www.pdqsupplyinc.com](http://www.pdqsupplyinc.com) • FB: [facebook.com/pdqsupplyinc](https://facebook.com/pdqsupplyinc)

## WR9X480

Timer, Defrost  
(factory i.d. #TMDJ625RB9)  
120V, 10 amp  
6 Hr. - 30 min.



## WR9X482

Timer, Defrost  
(factory i.d. #TMDJ830RH9)  
120V, 10 amp  
8 hr. - 30 min.



## WR9X483

(factory i.d. #TMDJX35RB9)  
10 Hr. - 30 min.

## WR9X502

(factory i.d. #TMDJ830RB9)  
8 Hr. - 30 min.

Timer, Defrost  
120V, 10 amp

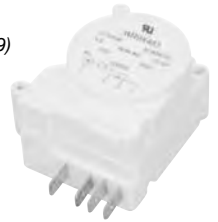

## WR9X489

Timer, Defrost  
(factory i.d. #TMDJZ35RE9)  
120V, 10 amp  
16 hr. - 35 min.



## WR9X548

(factory i.d. #TMDJ625RN9)  
6 hr. - 25 min.

## WR9X520

(factory i.d. #TMDJZ44RB9)  
15 hr. - 44 min.

Timer, Defrost  
120V, 10 amp

120V - 10 amp



## WR9X10041

Timer, Defrost  
(factory i.d. #TMDJY33RE9)  
120V, 10 amp  
12 hr. - 33 min.

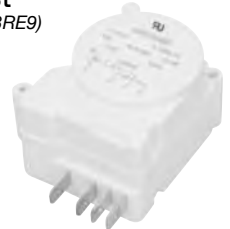

## WR9X10049

Timer, Defrost  
(factory i.d. #162D6022P029)  
(factory i.d. #TMDJZ34RE9)  
120V, 10 amp  
15 Hr. - 34 min.



## WR50X55

Thermostat,  
Defrost

L55-25F



Flat sensing head for surface mounts  
Has 11" lead wires w/ stripped ends

## WR50X112

L72-44F  
(1) 11" & (1) 22" lead wires

## WR50X122

L60-32F  
10" lead wires

Thermostat,  
Defrost

5/16" tube push-on clip  
Both have stripped wire ends



## WR50X124

L72-44F  
Has 24" lead wires

## WR50X134

L63-40F  
Has 24" lead wire

Thermostat,  
Defrost

7/16" tube push-on clip  
Both have stripped wire ends



## WR50X10010

Thermostat, Defrost  
L55-30F

5/16" tube push-on clip  
Has stripped lead wires -  
(1) 12-1/2" in length, (1) 16-1/2" in length



## WR50X10025

Thermostat, Defrost  
L58-30F

5/16" tube push-on clip  
Has stripped lead wires  
(1) 4" length, (1) 16" length



## WR50X10041

Thermostat, Defrost  
FR-5 14/5

5/16" tube  
push-on clip  
28" lead wires  
w/ stripped ends



## WR50X10071

Thermostat, Defrost  
L64-41F

5/16" tube push-on clip  
Has 15" stripped lead wires



## WR50X10065

Thermostat,  
Defrost  
L140-30F

5/16" tube push-on clip  
Has 11" stripped lead wires



**NEW**

CURRENT PRICING CAN BE FOUND ON OUR WEBSITE

All logos, trademarks, part numbers, photos & illustrations are intended solely for identification. Items offered for sale are not represented to be manufactured by the company that built the original equipment.

PHONE: 800-843-0903 • FAX: 800-344-1848 • WEB: [www.pdqsupplyinc.com](http://www.pdqsupplyinc.com) • FB: [facebook.com/pdqsupplyinc](https://facebook.com/pdqsupplyinc)

**WR30X311**  
Tray, Ice Cube  
12" x 4-1/2"

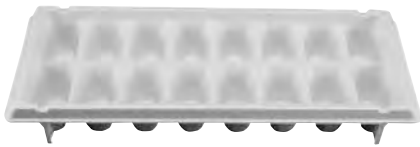

Heavy Duty - made of polypropylene

REFRIGERATOR PARTS

**WD35X151**  
Acid, Citric  
1/4 lb. combined



One application keeps glassware film free  
Two 1/8 containers of dry citric acid

DISHWASHER PARTS

**WD8X227** Right  
**WD8X228** Left  
Baffle, Corner Gasket

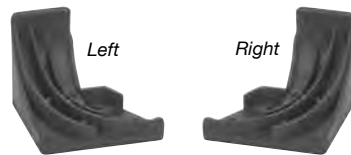

Used with gasket #WD8X229

**WD8X229**  
Gasket, Door



Profile at gasket ends

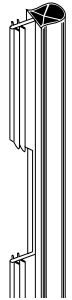

Has (2) U-shaped cutouts, each 7-1/2" from either end  
Cutouts are both 2-3/4" long  
89-1/4" overall length

**WD19X10032**  
Impeller, Pump Kit



**WD26X10013**  
Motor, Dishwasher Pump

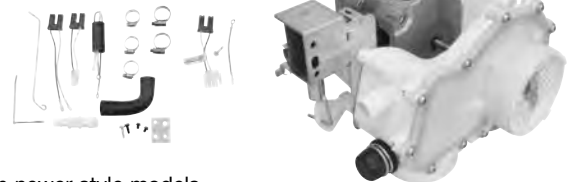

Used on newer style models  
Includes motor and pump adapter kit

**WD12X10267**  
Roller, Upper  
1-3/4" dia.  
1/2" thick



**WD12X271**  
Roller, Upper  
1-3/4" dia.  
3/4" thick



**WD12X10327**  
Rollers, Rack  
Sold as a set of 4



**WD21X10060**  
Solenoid



CURRENT PRICING CAN BE FOUND ON OUR WEBSITE

All logos, trademarks, part numbers, photos & illustrations are intended solely for identification. Items offered for sale are not represented to be manufactured by the company that built the original equipment.

LAUNDRY PARTS

**WH1X2026**  
Belt, Drive

**WASHER**

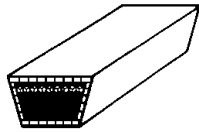

**WE12X82**  
Belt, Dryer  
1/4" width  
3/32" thick

**DRYER**

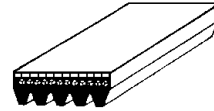

**WE1M536**  
Catch & Strike, Door

**DRYER**



**WE4X693**  
Coil, Main  
2 terminals

**DRYER**



For newer M series valves

**WE4X692**  
Coil, Primary  
3 terminals

**DRYER**



For newer M series valves

**WE11X103**  
Element, Heater  
20-1/4" dia.

**DRYER**



**WE25X60**  
Glide

**DRYER**



Used on older style gas and electric models from 1960-2002

**WE4X444**  
Igniter  
2-1/2" overall length

**DRYER**



Old style

**WE4X739**  
Igniter

**DRYER**



Current style  
Has a quick disconnect attached with  
2 male push-pin connections

**WE4X750**  
Igniter

**DRYER**



Has quick disconnect attached with  
2 male push-pin connections.

CURRENT PRICING CAN BE FOUND ON OUR WEBSITE

All logos, trademarks, part numbers, photos & illustrations are intended solely for identification. Items offered for sale are not represented to be manufactured by the company that built the original equipment.

PHONE: 800-843-0903 • FAX: 800-344-1848 • WEB: [www.pdqsupplyinc.com](http://www.pdqsupplyinc.com) • FB: [facebook.com/pdqsupplyinc](https://facebook.com/pdqsupplyinc)



**WE1X1263**

**DRYER**

Knob, Timer  
2-3/4" dia.  
1/8" ext. shaft

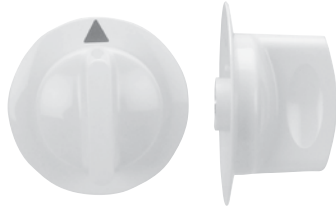
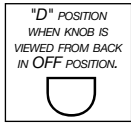

**WH1X2721**

**WASHER**

Knob, Timer  
1-3/4" dia.  
1/4" shaft ext.

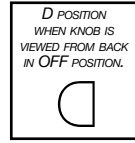

Has a red indicator line on hub

**WH23X10013**

**WASHER**

Pump



**WE18X54**

**DRYER**

Screen, Lint  
14-1/2" L x 2-1/2" W



**WE4X800**

**DRYER**

Switch, Thermostat Limit  
L310-100F

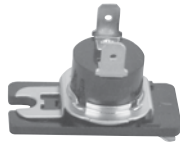

Has (2) .187" male terminals

**WH12X10338**

**WASHER**

Timer, Washer

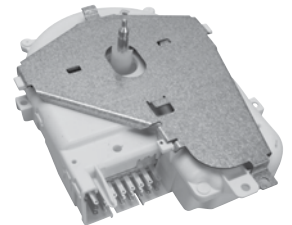

**WH13X10024**

**WASHER**

Valve, Water Fill

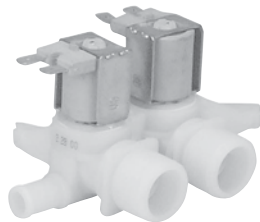

Used on current style models

**ERTB123A**

**WASHER**

Wrench, Tub Nut

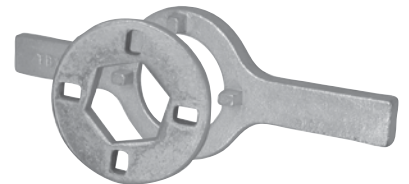

Removes tub nut from  
washing machine

*We have a knowledgeable and courteous staff waiting to assist you. Please let us know how we can serve you better. Call us at 800.843.0903 or log on to the internet at [www.pdqsupplyinc.com](http://www.pdqsupplyinc.com)*



**CURRENT PRICING CAN BE FOUND ON OUR WEBSITE**

*All logos, trademarks, part numbers, photos & illustrations are intended solely for identification. Items offered for sale are not represented to be manufactured by the company that built the original equipment.*

PHONE: 800-843-0903 • FAX: 800-344-1848 • WEB: [www.pdqsupplyinc.com](http://www.pdqsupplyinc.com) • FB: [facebook.com/pdqsupplyinc](https://facebook.com/pdqsupplyinc)